

RADIO'S LIVEST MAGAZINE

OVER 175 ILLUSTRATIONS

Radio-Craft

★

HUGO GERNSBACK Editor

SPECIAL
SHORT-
WAVE
NUMBER

January

25 Cents

In United States
and Canada

SHORT-WAVE RADIO
FOLLOWS THE RACES!

See Page 398



Short-Wave Radio in 1937 — How to Make the "Short-Wave Special"
How the "Radio Piano" Operates — Fun with Short-Wave Apparatus

OVER 50,000 RADIO MEN READ RADIO-CRAFT MONTHLY

6 REASONS WHY SUPREME



Model 546 3" Cathode
Ray Oscilloscope
\$6.50 down—\$5.95 for
10 months. **Cash Price \$59.95**

VISUAL SERVICING will increase YOUR profits!



Model 581
Signal Generator
\$6.00 down—
\$5.44 for 10
months on S.I.
C. terms.
Cash
Price **\$54.95**

ALL visual servicing is not alike! That's why you should demand proof of its accuracy and profit-making ability—before you buy!

Shown here are six profitable short-cuts that not only allow you to do service work *more quickly*, but *more efficiently*! They are only a few of the many dozens of uses to which you can place your Supreme Model 581 Signal Generator and your Supreme Model 546 3" Cathode Ray Oscilloscope—the perfect instrument combination for Visual Servicing because they were both designed to work together!

Check the features of the Supreme 581 Signal Generator and Frequency Modulator: Razor-Edge *Shadow Tuning*—Giant 340 degree dial—38 to 1 knob to condenser ratio—actual 8 feet long scale length—125 KC to 60 MC on 8 bands—can be used as (1) Unmodulated RF oscillator (2) 400 cycle—30% amplitude modulated RF oscillator (3) 24 KC fixed band width frequency modulated RF oscillator (for visual alignment) (4) Externally amplitude modulated RF oscillator (5) Fixed 400 cycle AF oscillator (6) Variable 60 to 10,000 cycle AF oscillator (7) Power supply frequency time base for scope.

Check the features of the Model 546: 3" Cathode Ray Oscilloscope:—(1) Lowest price complete 3" tube scope (2) 0 to 90,000 cycle linear vertical and horizontal gain controlled amplifiers (3) 15 to 30,000 cycle saw toothed linear time base (4) "Snap Lock" Synchronization circuit (5) Internal or external synchronization circuit (6) All controls including "Spot Centerers" on panel (7) D.C. or A.C. signal can be fed direct to deflecting plates.

For the utmost in high precision, low cost, latest design and complete satisfaction, see SUPREME before you buy!

Combination Offer! Model 546 3" Oscilloscope, Plus Model 581 Signal Generator, Only \$11.50 down—\$9.48 per month for 12 months.

Sold on Supreme S.I.C. Terms—the world's easiest installment terms!

SUPREME INSTRUMENTS CORP.

Greenwood, Miss., U. S. A.

Export Dept., Associated Exporters Co., 145 W. 45th St., New York City • Cable Address: Lopreh, New York

HERE ARE THE 6 REASONS!

1. Visual Alignment—



Only by using this type equipment can R. F. and I. F. circuits on modern, high fidelity receivers be properly aligned.

2. Audio Response—

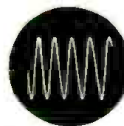

Only by using this type equipment can over-all audio response and "stage-by-stage" analysis measurements be made quickly and accurately in both receivers and P.A. or theater amplifiers.

3. Hum Check—



Only by using this type equipment can objectionable hum be quickly traced and eliminated.

4. A. F. Amplifier Overload—



Only by using this type equipment can audio frequency distortion caused by overload or phase shift be located and corrected.

5. I. F. Amplifier Overload—

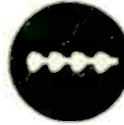

Only by using this type equipment can I.F. overload with resulting A.F. signal distortion be found and removed.

6. Demodulator Distortion—



Only by using this type equipment can Demodulator Output Waveforms be checked and distortion or possible presence of R.F. be located.

A FREE LESSON SHOWED BILL HOW HE COULD MAKE GOOD PAY IN RADIO



BILL, YOU'RE ALWAYS FOOLING WITH RADIO --- OUR SET WON'T WORK --- WILL YOU FIX IT?

I'LL TRY, MARY, I'LL TAKE IT HOME TONIGHT



I CAN'T FIND OUT WHAT'S WRONG --- GUESS I'LL MAKE A FOOL OF MYSELF WITH MARY



HELLO, BILL --- GOT A TOUGH ONE TO FIX? LET ME HELP YOU



HELLO JOE --- WHERE'VE YOU BEEN LATELY --- AND WHERE DID YOU LEARN ANYTHING ABOUT RADIO?

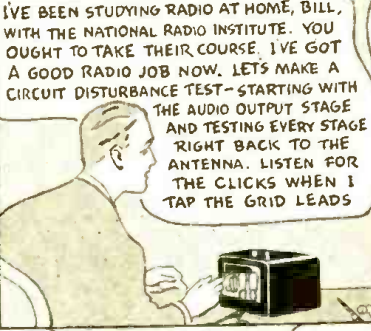

I'VE BEEN STUDYING RADIO AT HOME, BILL, WITH THE NATIONAL RADIO INSTITUTE. YOU OUGHT TO TAKE THEIR COURSE. I'VE GOT A GOOD RADIO JOB NOW. LET'S MAKE A CIRCUIT DISTURBANCE TEST --- STARTING WITH THE AUDIO OUTPUT STAGE AND TESTING EVERY STAGE RIGHT BACK TO THE ANTENNA. LISTEN FOR THE CLICKS WHEN I TAP THE GRID LEADS



SAY --- WHERE DID YOU LEARN THAT TEST? IT'S A GOOD ONE

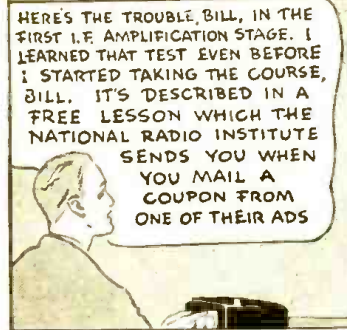

HERE'S THE TROUBLE, BILL, IN THE FIRST I.F. AMPLIFICATION STAGE. I LEARNED THAT TEST EVEN BEFORE I STARTED TAKING THE COURSE, BILL. IT'S DESCRIBED IN A FREE LESSON WHICH THE NATIONAL RADIO INSTITUTE SENDS YOU WHEN YOU MAIL A COUPON FROM ONE OF THEIR ADS



I'VE SEEN THEIR ADS BUT I NEVER THOUGHT I COULD LEARN RADIO AT HOME --- I'LL MAIL THEIR COUPON RIGHT AWAY

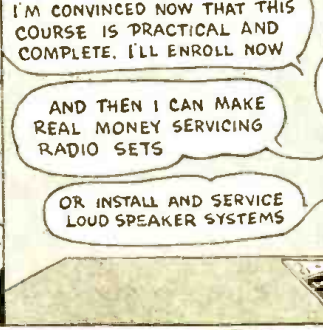

I'M CONVINCED NOW THAT THIS COURSE IS PRACTICAL AND COMPLETE. I'LL ENROLL NOW

AND THEN I CAN MAKE REAL MONEY SERVICING RADIO SETS

OR INSTALL AND SERVICE LOUD SPEAKER SYSTEMS



OR GET A JOB WITH A RADIO BROADCASTING OR TRANSMITTING STATION

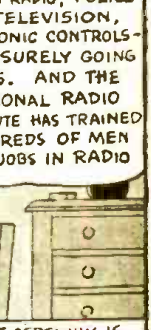

AVIATION RADIO, POLICE RADIO, TELEVISION, ELECTRONIC CONTROLS --- RADIO IS SURELY GOING PLACES. AND THE NATIONAL RADIO INSTITUTE HAS TRAINED HUNDREDS OF MEN FOR JOBS IN RADIO

I will send you a Lesson on Radio Servicing Tips FREE TO SHOW HOW PRACTICAL IT IS TO TRAIN AT HOME FOR GOOD JOBS IN RADIO



J. E. SMITH
President
National Radio Institute
Established 1914
The man who has directed the home study training of more men for the Radio Industry than any other man in America.



YOU CERTAINLY KNOW RADIO SOUNDS AS GOOD AS THE DAY I BOUGHT IT.

THANKS! IT CERTAINLY IS EASY TO LEARN RADIO THE N.R.I. WAY. I STARTED ONLY A FEW MONTHS AGO, AND I'M ALREADY MAKING GOOD MONEY.

THIS SPARE TIME WORK IS GREAT FUN AND PRETTY SOON I'LL BE READY FOR A FULL TIME JOB

Do you want to make more money? I'm sure I can train you at home in your spare time for a good Radio Job. I'll send you a sample lesson FREE. Examine it, read it, see for yourself how easy it is to understand even if you've never had technical experience or training.

tant Radio principles. My training gives you practical Radio experience while learning.



I Give You a Professional Servicing Instrument

Here is the Instrument every Radio expert needs and wants---an All-Wave, All-Purpose, Set Servicing Instrument. It contains everything necessary to measure A.C. and D.C. voltages and current; test tubes, resistance; adjust and align any set, old or new. It satisfies your needs for professional servicing after you graduate. can help you make extra money servicing sets while training.

Many Radio Experts Make \$30, \$50, \$75 a Week

Radio broadcasting stations employ engineers, operators, station managers and pay up to \$5,000 a year. Spare time Radio set servicing pays as much as \$200 to \$500 a year. Full time Radio servicing jobs pay as much as \$10, \$50, \$75 a week. Many Radio Experts operate their own full time or part time Radio sales and service businesses. Radio manufacturers and jobbers employ testers, inspectors, foremen, engineers, servicemen, buying up to \$6,000 a year. Radio operators on ships get good pay, see the world besides. Automobils, police, aviation, commercial Radio, and loud speaker systems offer good opportunities now and for the future. Television promises many good jobs soon. Men I trained have good jobs in these branches of Radio.

Many Make \$5, \$10, \$15 a Week Extra In Spare Time While Learning

Almost every neighborhood needs a good spare time serviceman. The day you enroll I start sending you Extra Money Job Sheets. They show you how to do Radio repair jobs, how to reach in quickly. Throughout your training I send you plans and ideas that have made good spare time money---from \$200 to \$500 a year---for hundreds of fellows. I send you special Radio equipment, show you how to conduct experiments, build circuits illustrating impor-



OH BILL --- I'M SO GLAD I ASKED YOU TO FIX OUR RADIO. IT GOT YOU STARTED THINKING ABOUT RADIO AS A CAREER. AND NOW YOU'RE GOING AHEAD SO FAST

OUR WORRIES ARE OVER. I'M MAKING GOOD MONEY NOW, AND THERE'S A BIG FUTURE AHEAD FOR US IN RADIO

J. E. SMITH, President, Dept. BAX National Radio Institute, Washington, D. C.

Dear Mr. Smith: Without obligation, send me a sample lesson and your free book about the spare time and full time Radio opportunities, and how I can train for them at home in spare time---about the N.R.I. Set Servicing Instrument you give me. (Please write plainly.)

Name Age

Address

City State

Get My Lesson and 64-Page Book FREE--- Mail Coupon

In addition to my Sample Lesson, I will send you my 64-page book, "Rich Rewards in Radio." Both are free to any fellow over 16 years old. My book points out Radio's share time and full time opportunities and those coming in Television; tells about my Training in Radio and Television; shows my Money Back Agreement; shows you letters from men I trained, telling what they are doing, earning. Find out what Radio offers YOU! MAIL THE COUPON in an envelope, or paste it on a penny postcard---NOW!

J. E. Smith, Pres., National Radio Institute
Dept. BAX Washington, D. C.

Please Say That You Saw It in RADIO-CRAFT



HUGO GERNSBACK, Editor-in-Chief
 N. H. LESSEM Associate Editor
 R. D. WASHBURNE, Managing Editor
 C. P. MASON Associate Editor

CONTENTS—JAN. 1938, ISSUE

Volume IX Number 7

Editorial: Short Waves of TomorrowHugo Gernsback 389

The Radio Month in Review..... 390

Short-Wave Radio Marches On!.....W. E. Shrage 392

Radio in Pictures..... 394

Flickerless Film-Television 395

How to Make the 4-Tube "Short-Wave Special"
Howard G. McEntee and Donald Lewis 396

Short-Wave Radio Follows the Races!...N. H. Lessem 398

Remote Mixing Accomplished in Latest P.A. Systems 398

New Tubes for Short Waves, Public Address and
 Other Services.....R. D. Washburne 399

Fun with Short-Wave Radio Apparatus
Nelson G. Haas 400

Latest Tone-Controlled Electronic Piano
H. K. Bretsfelder 402

"Ham" Set Uses New Tuned-Crystal Filter Circuit... 403

Television Students Learn by Making Cathode-Ray
 Tubes—Part III.....U. A. Sanabria 403

How to Make the *Radio-Craft* Super-Deluxe 30-Tube
 Set—Part IV 404

New Circuits in Modern Radio Receivers—No. 4
F. L. Sprayberry 406

Servicing Questions & Answers..... 407

Operating Notes 407

How to Make a 2-Way "Ham" Station for 5-Meter
 Phone.....J. B. Carter 408

"Learn-by-Experimenting" Beginners' Practical Radio
 Course—Experiment No. 4.....Sol D. Prensky 410

How Dependable Are Your Meter Readings?—Part
 IV.....Alfred A. Ghirardi 412

"Snow Static" Being Beaten by "Flying Laboratory"
 —Part III.....H. M. Hucke 413

Business Problems of the Service Man.....Jack Grand 414

How to Conduct a Sound-on-Film Recording Studio
 —Part II.....I. Queen 415

The Latest Radio Equipment..... 416

RADIO SERVICE DATA SHEETS:
 No. 219—International-Kadette Model 1019 A.C.
 Superhet. 418

No. 220—Crosley Fiver Chassis, "Chairside" Model
 567 419

Radio Wittiquiz 420

ORSMA Members' Forum..... 420

Book Review 387A

ANNUAL BROADCAST NUMBER

February *Radio-Craft*, on the newsstands January 1, will contain articles of interest not only to the broadcast listener and technician, but also articles relating to other fields. Short-Waves, Electronics and Public Address—all these activities will be represented; also, February *Radio-Craft* will contain articles of exceptional interest to the Service Man as well as more elementary articles for the radio beginner.

Published by Radcraft Publications, Inc. Publication office: 29 Worthington Street, Springfield, Mass. Editorial and Advertising Offices: 99 Hudson Street, New York City. Chicago Advertising Office: RADIO-CRAFT, 520 North Michigan Avenue, Chicago, Ill.

Foreign Agents:

London—Gorrings American News Agency, 9A Green St., Leicester Square, W. C. 2, England.
 Paris—Messageries Dawson, 4 Rue Faubourg, Poissonniere, France.
 Melbourne—McGill's Agency, 179 Elizabeth St., Australia.
 Dunedin—James Johnston, Ltd., New Zealand.

RADIO-CRAFT is published monthly, on the first of the month preceding that of date; subscription price is \$2.50 per year in U. S. and Canada. (In foreign countries, \$3.00 a year to cover additional postage.) Entered at the post office at Springfield as second-class matter under the act of March 3, 1879.

Text and illustrations of this magazine are copyright and must not be reproduced without permission of the copyright owners.

Copyright 1937. Radcraft Publications, Inc.

By Doing Actual Jobs—Not Correspondence—On Modern Radio Equipment



View of Students operating our Television Camera and Scanning Unit

TRAIN IN 12 WEEKS

In the Big Chicago Shops of **COYNE**



Students operating our modern Transmitter

TELEVISION

FOR RADIO

TALKING PICTURES

No Advanced Education or Previous Experience Needed to Master Thorough, Practical Coyne Training

“Learn by Doing” methods train you for RADIO, TELEVISION and SOUND EQUIPMENT—NOT A CORRESPONDENCE COURSE—NO BOOK STUDY—YOU DON’T HAVE TO RECITE LESSONS IN A CLASSROOM—you DON’T NEED advanced education or previous Radio Experience. You are trained right in modern, daylight shops on Radio, Sound and Television equipment under the personal supervision of expert instructors on the sort of similiar work you will meet out in the field on a real job. That’s why Coyne Practical Training is able to prepare you in such a short time. SPEND ONLY 12 WEEKS DOING ACTUAL WORK AT COYNE, and you should be ready for your start to a better job and a real future. Do radio wiring and testing, trouble shooting, repairing and servicing. Work on a wide variety of Superheterodyne sets, oscillators, analyzers and test instruments. Learn how to operate television receiving and transmitting equipment; to install, test and service public address systems and sound picture equipment. Prepare to qualify for a government license examination as Amateur, Broadcast, or Telegraph Radio Operator and to know code and Dept. of Commerce rules.

Amazing Offer!

PAY FOR YOUR TRAINING AFTER YOU GRADUATE

in Small Monthly Payments!

Don't let lack of money stop you from sending in the Coupon. Learn how you can get your training first—Then take over one year to pay tuition after you graduate. Make your first payment 60 days after your regular 12 Weeks Training period ends. Then take over a year to pay the

balance in small monthly payments. This plan has enabled hundreds of ambitious fellows to get Coyne Training with very little money. It can do the same for you. Many of our graduates have found their extra earnings more than enough to cover the small monthly payments.

Earn Living Expenses While You Are Training!

If you need part-time work to help pay your living expenses while training, my free employment service will help you get it. The Free Service of our Employment Department has enabled hundreds of deserving students to get part time jobs and earn part or all of their room and board while training in the great Coyne Chicago Shops.

Electric Refrigeration

Training Included Without Extra Cost

This combination Training (Radio and Refrigeration) can be of great value to you. Whether you go into business for yourself or get a job working for a Radio Sales and Service organization, the fact that you are trained in servicing Electric Refrigerators will be profitable to you. Many Radio Manufacturers also make Electric Refrigerators and men with this combination training are much more valuable to these employers. You can NOW get this training without extra cost.



You Get Employment Service After You Graduate

Our Graduate Employment Service will give you employment service as often as you need it. You will also get free consultation service and advice whenever you want it.

Mail The Coupon

Get the new “Coyne Opportunity Book” giving all facts about Coyne Training. Photographs of Shops showing students at work on modern Radio equipment under the personal supervision of Coyne Expert Instructors. Also details of our Part Time Employment Service, Pay After Graduation Plan and Graduate Employment Service. Yours without cost. Simply mail the coupon.

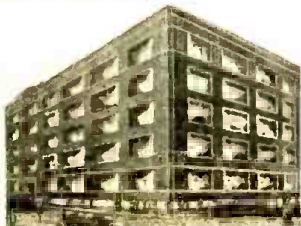

Home of Coyne Shops

This is our fireproof modern building wherein is installed thousands of dollars worth of Radio equipment of all kinds. Every comfort and convenience has been arranged to make you happy and contented during your Training.

H. C. LEWIS, President—RADIO DIVISION
Coyne Electrical School, Dept. 18-8H
500 S. Paulina St., Chicago, Ill.

Send me your Big Free Book about Coyne Training and give me all details regarding your Part Time Employment Service and Pay After Graduation Plan of easy, monthly payments.

NAME.....AGE.....
ADDRESS.....
CITY.....STATE.....
Mail in envelope or paste on Postcard

COYNE RADIO DIVISION ELECTRICAL SCHOOL H. C. LEWIS President
500 S. Paulina St., Dept. 18-8H, Chicago, Ill.

Please Say That You Saw It in RADIO-CRAFT

Q U I E T

SILENT SPIRAL CONNECTOR

PATENTS APPLIED FOR



5-FINGER KNEE ACTION ELEMENT CONTACT

IRC HAS SPARED NO EXPENSE SO THAT YOU CAN BE SURE

Study the design of IRC Metallized Controls. Note in particular the precision construction of the 5-Finger "Knee Action" Silent Element Contact and the new Silent Spiral Connector.

Each of these exclusive features means thousands of dollars in research by IRC engineers. Each means additional manufacturing expense—yet IRC Controls cost you no more than ordinary controls having neither of these noise-eliminating features.

It is "plus" values such as these that have made IRC resistance products famous the world over. By giving you the greatest value for your money, by doubly insuring you against customer complaints, we protect our reputation by helping you protect yours. That is good business for both of us!

Silent Spiral Connector available on IRC Special Replacement Controls listing at \$1.50 and up . . . designated in Guide with prefix "J".
5-Finger "Knee Action" Silent Element Contact supplied on all IRC Controls.



Metallized TYPE VOLUME CONTROLS

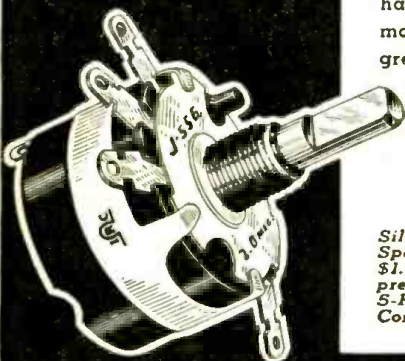

INTERNATIONAL RESISTANCE COMPANY

401 NORTH BROAD STREET, PHILADELPHIA, PA.

Factories or Licensees in Canada, England, France, Germany, Italy, Denmark and Australia

MAKERS OF RESISTANCE UNITS OF MORE TYPES, IN MORE SHAPES, FOR MORE APPLICATIONS THAN ANY OTHER MANUFACTURER IN THE WORLD

BOOK REVIEW

RADIO AMATEUR COURSE (First 1938 Edition), by G. W. Stuart. Published by Short Wave and Television magazine. Size, 6½ x 9½ ins., stiff paper covers, 144 pages, about 150 illustrations. Price, 50c.

Please excuse your reviewer, if he waxes a bit enthusiastic, but here is the answer to the prayer of the radio beginner who wants to master first principles from the letter A.

Never before has the amateur radio field been covered in such elementary manner. The volume not only starts the beginner with a primer course in alternating current but also uses similes and picture illustrations never before presented in book form. Printed on fine, hard-finish paper, all of the illustrations have reproduced perfectly.

The treatment of the fundamentals of radio is so thoroughly and simply carried out that we do not hesitate to recommend "Radio Amateur Course" to the beginner in any branch of radio. The volume is unusually concise and straightforward in its presentation.

Do not make the mistake of believing that "Radio Amateur Course" deals only with fundamental principles. Actually it carries the reader right on through the practical design and construction of amateur transmitting and receiving equipment even to a complete 400-W. station; including intermediate variations in wavelength and power. (An excellent working treatise on "how to get started in amateur radio" is comprised of "Radio Amateur Course" and its companion book "How to Become an Amateur Radio Operator and Secure a U.S. Government License.")

THE CAUSES AND ELIMINATION OF RADIO INTERFERENCE, by Joseph Everett Foster. Published by C. W. Nelson Company. Size, 4 x 7 ins., cloth covers, 151 pages, 35 illustrations. Price, \$1.50.

Contains previously unpublished information concerning radio interference and its elimination. The author, Radio Interference Engineer with the Long Island Lighting Company, discusses the methods for radio interference location and elimination actually practiced by a large power company. A wealth of technical information is presented; in general, however, the textual description is kept in light vein. Although not intended as a commercial plug, one well-known manufacturer of anti-noise equipment receives a well-earned publicity break. Chapter headings are of interest.

Chapter I—Fundamental Principles of Radio; Chapter II—The Cause of Radio Interference in the Average Home; Chapter III—Radio Interference Caused by Electric Light and Power Lines; Chapter IV—Radio Interference Caused by 2,300 and 4,400 Volts Distribution (Primary) Feeders; Chapter V—Radio Interference Caused by High-Tension Transmission Feeders; Chapter VI—Radio Interference Caused by Street Lighting Circuits; Chapter VII—Uses of Interference Locator in Underground Cable Work; Chapter VIII—The Relation Between Electric Light and Power Companies, and Radio Dealers and Service Men.

TELECOMMUNICATIONS, by James M. Herring and Gerald C. Gross. Published by McGraw-Hill Book Co., Inc. Size, 6 x 9¼ ins., cloth covers, 544 pages. Price, \$5.00.

This book on telecommunications ("Any telegraph or telephone communication of signs, signals, writings, images, and sounds of any nature, by wire, radio, or other systems or processes of electric or visual [semaphore] signaling.") deals with matters pertinent to the telephone, telegraph, cable, and radio industries.

It presents first a factual background, dealing with the development of the communication industries, the sources of revenues and the factors affecting costs, rate-making, and consolidation. This is followed by description and analysis of Federal regulation of communications prior to 1934, and of state regulation of communications. A detailed analysis of the Communications Act of 1934 is presented, and in the final chapter a consideration of what has been done, and what has been left undone, by way of law and regulation from the viewpoint of sound national policy.

Please Say That You Saw It in RADIO-CRAFT

Be a RADIO EXPERT

THE ONE MAN IN 1000 WHO CAN SERVICE MODERN RADIO RECEIVERS

RADIO SERVICE WORK NOW OFFERS GREATEST OPPORTUNITIES SINCE RADIO BEGAN.....

Radical changes have taken place in radio receiver design during the past year. Circuits and construction are very different from the receivers with which the radio service industry has had its greatest experience. Even more sensational developments with further complications are coming next season. Who will service these receivers? Certainly not the "old timer" who knows nothing about modern receivers! He can't do it. That is why, right now, there is an urgent demand for reliable service men with up-to-the-minute knowledge of modern radio receivers. Such men can step right out and earn up to \$3 an hour doing nothing but pleasant service work in the better homes around town.



Important and far-reaching developments in Radio create sudden demand for specially equipped and specially trained Radio Service Men.



THIS CIRCUIT ANALYZER AND POINT-TO-POINT RESISTANCE TESTER INCLUDED FREE OF EXTRA CHARGE. Also FOUR LARGE KITS OF HOME PRACTICE EQUIPMENT.....

No Past Experience Needed
Past experience actually counts for little at this time, because the swift changes in receiver construction have made knowledge of old equipment practically useless. Even though you may not know one tube from another today . . . still, you can take R.T.A. training and make more money servicing modern radios than most of the "old timers" are making. R.T.A. graduates are doing it every day. Many of them are making more money as R.T.A. Certified Radio Technicians than they ever made in their lives before!

Be An R. T. A. Man and You'll Be the One Man in 1000

R.T.A. training will equip you to give fast, complete service to any radio receiver built. The jobs that puzzle and sometimes baffle the usual service man will be simple as "A.B.C." to you . . . when you become an R.T.A. Certified Radio Technician. It is very possible that you will be the only service man in your locality able to quickly diagnose and quickly repair the new types of radio receivers. Be the one man in 1000! You can.

IT'S JUST AS SIMPLE AS THIS

OF COURSE I CAN FIX IT!

NOW THE SET SOUNDS GREAT! TWO OTHER MEN HAVE TRIED TO FIX IT BUT COULDN'T DO IT

I MADE \$18 TO-DAY! THERE'S NOBODY ELSE IN TOWN WHO CAN FIX THESE NEW SETS

R. T. A. Membership Valuable

With your course of training, and as long afterward as you may need help, you always have available, without extra cost, valuable consultation service on any problem that may arise in your radio service work or on any of the newer developments that may appear in new radio receivers from time to time.

To Help You Make Money Quickly

R.T.A. supplies you with an excellent and reliable Circuit Tester and Point-to-Point Resistance Checker as is illustrated above—one of the handiest pieces of portable service equipment. It quickly helps you locate trouble in any type of radio receiver, old or new.

SEND COUPON

A. G. Mohaupt, Engineer
Radio Training Ass'n. of America
Dept. RC-18, 4525 Ravenswood Ave., Chicago, Ill.

Dear Mr. Mohaupt: Please send me your free book of facts about radio opportunities and how I can make big money quickly. Also tell me how I can obtain your Circuit Analyzer and four big experimental outfits.

Name

Address

City State

RADIO TRAINING ASSOCIATION of AMERICA
4525 Ravenswood Avenue CHICAGO, ILLINOIS

Please Say That You Saw It in RADIO-CRAFT

Here is a **NEW FREE BOOK** Which Every Radio Man Can Use to Advantage!

Your Last Opportunity to Get This Book!
This Offer Expires December 31, 1937.

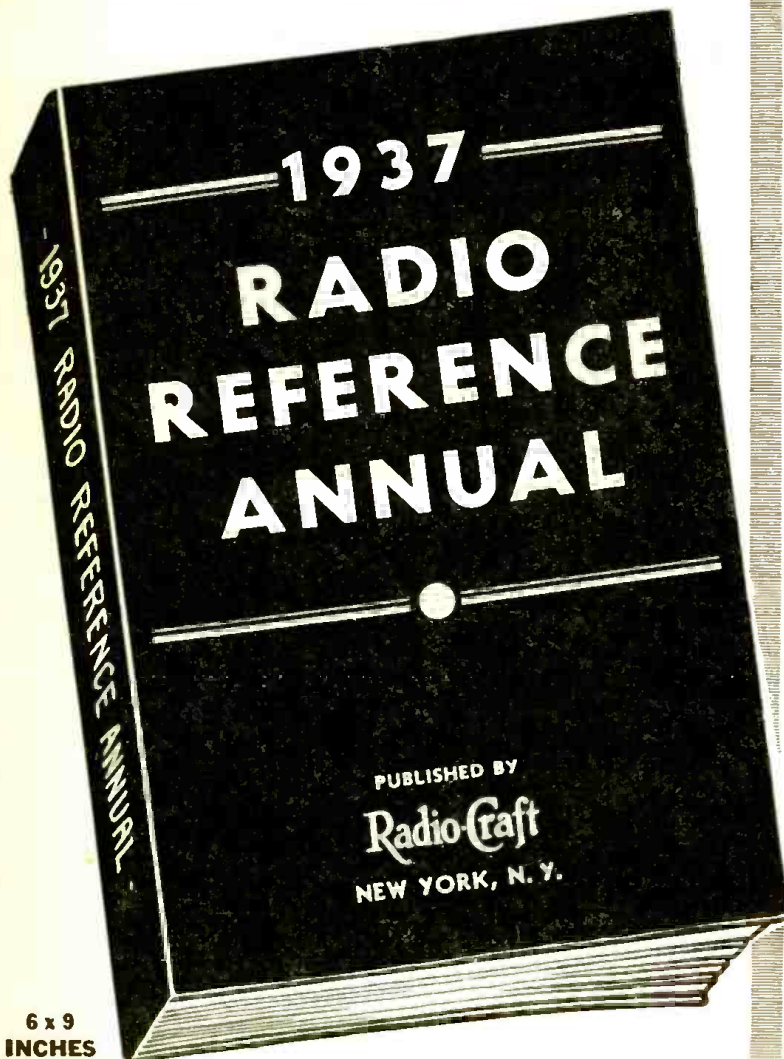

OVER 125 ILLUSTRATIONS

THE Editors of RADIO-CRAFT have prepared a special book for you. This book—1937 RADIO REFERENCE ANNUAL—is not for sale, but available only to subscribers, both new and old, with a *Seven Months' Subscription* to RADIO-CRAFT. If your subscription expires shortly, you have the privilege of extending your subscription for seven months, and still receive the FREE premium. The price of this Special Offer is only One Dollar (\$1.00)—and as an additional saving, the book is mailed to you *post-paid*, just as the magazine is each month. Carefully outlined at the top right column is the contents of this book; it contains information which every radio man needs. The book contains 64 pages, size 6 x 9, and is replete with illustrations.

RADIO-CRAFT
99 Hudson Street, New York, N. Y.

Read These Interesting Chapter Headings of 1937 RADIO REFERENCE ANNUAL

Receiver Construction

Building a 12-tube All-wave DX receiver—How to make a modern 6-tube Car Radio set—building up a 2-tube Beginner's Set, with several different power supplies for various uses—Constructing a 2-tube midget set for portable use—How to build a "talking" briefcase—no aerial or ground needed.

Audio and P. A. Equipment

Making an Audio Bass Booster, using direct coupling—How to build and add a Dual-Channel Amplifier to your receiver—Constructing a High-Fidelity Amplifier—Construction of a 3-tube A.C.-operated Preamplifier—Fundamentals of "Decibel Level" and "Decibel Gain".

Test Equipment — Construction

How to make an "Electronic Eye" output meter—How to construct an ultra-compact Universal Volt-Ohm-Milliammeter—How to make a Resistance-Capacity tester—How to Build a Pocket Adapter for set testing—Building a Portable Capacity bridge—Construction of a V.T. Voltmeter in compact form—How to Make a Modern Set Analyzer.

Articles for the Service Man

Servicing with the Oscilloscope—Servicing with a Single Meter—"What's Wrong With Your Radio" chart—Tapers of Volume Controls, and use of various types—Ideas for the Service Shop—Aligning All-Wave receivers.

Time and Money-Saving Kinks

In this section you profit by the experience of other radio men. These kinks are really valuable "short-cuts" which save much time and, very often, money. They are "pet" ideas put into practice.

Important Articles Which Have Appeared in RADIO-CRAFT

General Interest Articles

Design of Transformers for Class "AB" and "B" operation—A table of Inter-Electrode Capacities for 30 different tube types—How to make a Floating-Grid Relay—Construction of a modern Treasure Locator—How to get DX on your All-Wave Radio—Making a 5-meter Transceiver for use in car or boat.

New Tubes

Characteristics of the Newest Receiving Tubes of all manufacturers, giving uses, characteristics, present equivalents (if any) and all pertinent data.

MAIL COUPON TODAY!

RADIO-CRAFT, 99 Hudson St., New York, N. Y.

Gentlemen: Enclosed you will find my remittance of One Dollar (\$1.00) for which enter my subscription to RADIO-CRAFT Magazine for Seven Months. Send me ABSOLUTELY FREE, and POSTPAID, my copy of 1937 RADIO REFERENCE ANNUAL. (This Offer is Good Only in U.S.A. and Canada—Foreign \$1.50.)

Name Address

City State

(Send remittance by check or money order. Register your letter if you send cash or unused U. S. Postage Stamps.) RC-1-38

Please Say That You Saw It in RADIO-CRAFT



"Takes the Resistance out of Radio"

Editorial Offices: 99 Hudson St., New York, N. Y.

HUGO GERNSBACK, Editor

Vol. IX, No. 7, January, 1938

SHORT WAVES OF TOMORROW

An Editorial by HUGO GERNSBACK

EVERY SO OFTEN remarks are made that short waves have now settled down into routine business, as the telegraph and telephone did before; and that nothing much more is to be invented, since all the major short-wave inventions have been made.

This silly argument is on a par with the famous story of the Patent Examiner in the United States Patent Office who, about the year 1870, resigned his official position because he was convinced that everything worthwhile and important had been invented, and he saw no future in patents! This poor unimaginative individual, if he were alive today, would probably be very much discomfited; because some of the century's greatest inventions were made between the years 1870 and 1900. The telephone, motion pictures, induction motors, X-rays, airplanes and, literally, thousands of other important and revolutionary inventions were made after he delivered his ridiculous dictum. The same reasoning applies to short waves; and the present uses of short waves are only an infinitesimal percentage of what yet remains to be done.

You will remember that although short waves have been known for about 50 years, actually, they were not used on a large scale much more than 10 years ago—certainly much too brief a time to explore such a great domain as Short Waves. By far the greatest short-wave inventions and applications lie in the distant future. Our instrumentalities are still woefully inadequate, and our entire radio technique is still exceedingly crude. If you don't believe this, save this editorial for twenty-five years and then look about you at the end of that time. You will probably smile good-naturedly at our present-day feeble efforts; just as we laugh today when we contemplate our so-called radio or "wireless" instrumentalities of the vintage of 1912.

Our short waves, of course, will remain the same short waves 25 years or more hence; but the instrumentalities and apparatus we are going to use at that time will bear no resemblance to what we are using today.

Originally, radio started out with the *crystal* set which required no local energy of any kind. Later, we had the *battery-operated* sets, because batteries were required to operate our first tubes which gave better results than the crystal. Still later, we used the house *A.C.* or *D.C.* power supply, discarding the batteries except for certain portable sets. But already, we are turning to the strictly personalized set; for instance, policemen in a number of foreign countries are now fully radio-equipped and are walking about the city streets with complete short-wave radio transmitters

and receivers, battery-operated. I can visualize the future receiver without batteries of any kind or, if batteries will be used, they will be not much larger than a few fountain pens. Personalized receivers in the future will enable people to listen in (and also transmit if necessary) while walking about; yet the entire instrument will fit into your vest pocket. The loudspeaker, which will also be the microphone, will be no larger than your wristwatch and will be worn in the same fashion. This, by the way, is a prediction made by David Sarnoff, President of RCA, not so long ago.

If Amelia Earhart, on her bold adventure, had been equipped with modern short-wave apparatus (or if short-wave directional receivers had been more fully developed), the results might have been different. As it was, her transmitter went bad the minute the propeller stopped revolving, because the power required to operate the radio-current generator came from the engine. Once the plane was down, no further communication with the outside world could be effected. Yet, even with the means available today Miss Earhart could have carried a short-wave telephone transceiver in one of the wings. This apparatus, battery-operated, would have weighed less than 20 lbs.; yet with it she could have given her position or, if she did not know it she could have ASKED for her position by communicating with the mainland while the plane was still afloat. Amateurs would have picked up her call in many different countries; and it would have been only a matter of minutes for the world to know at what point she landed in the Pacific Ocean, and it would have made the subsequent hunt far easier.

In the meanwhile, tomorrow's radio instrumentalities will be further and further refined as time goes on. Tubes will diminish in size, and will become enormously more sensitive and effective than they are today. This immediately makes it possible that, with a very few watts (much less than the power used by a small electric light bulb) we will literally be able to span the entire world with radio communication, using nothing but a small handful of short-wave instruments. Indeed, the vogue of high-power short-wave transmission is probably drawing to a close. In Marconi's day, thousands of kilowatts were necessary to transmit even a weak signal across the ocean. Today, the average amateur thinks nothing whatsoever of hurdling the globe with signals of 20 watts or less. Even the high-power stations now in use by broadcasters will no longer be so powerful; because there will be no necessity for high-power transmission, with the advent of more sensitive and efficient radio receivers. Thus short waves constitute a tremendous field for endeavor.

THE RADIO MONTH



(General Electric photo)

Mayor LaGuardia opens New York City's new \$50,000 2-way radophone system, linking 9 fireboats with fire headquarters. Fire Alarm Central Office is in Central Park; main transmitter, of 500 W., is in Long Island City, N. Y., and operates on a frequency of 1,630 kc. Five pick-up receivers at strategic land points permit successful reception of the fireboats' 50-W. signals, on 35-6 megacycles, wherever they may be in New York Harbor.



(NBC photo)

Actors proverbially hug the limelight; but this fence keeps William Farnum, John Barrymore, et al., from hugging the mike during a streamlined Shakespeare revival.

TELEVISION LOOKS FOR SPONSORS

LIKE the theatrical producer who seeks, not a star, but an "angel," television has already solved most of its problems except sponsoring sufficient programs to give varied entertainment. Demonstrating RCA's new cathode-ray projection tube on a 3x4-foot screen, President David Sarnoff said that the cost of the programs is as formidable as anything facing the technical men.

A few days before, a sound motion picture of public health activities had been shown to the convention of the A.P.H.A. in New York; and, *even at its present development*, radiovision would be of great worth in such activities as Chicago's "radio school."

In Germany last month, engineers sent 180-line television images 1,000 miles by wire with a new special cable—that is, from Berlin to Munich and back.

To police communication officers, Col. Edwin B. White of F.C.C. last month predicted that television will play a great part in law enforcement. A week later the commission established 19 ultra-shortwave channels, each 6 megacycles wide, for television work.

In England, the B.B.C. is building a \$3,500,000 radio-television studio block, as part of a 6-year program; former studios will become offices. In the meantime, work goes on; last month a football team watched mates' practice, by television, in preparation for transmitting the season's games. And during the past year, *elaborate makeup* for the camera *became almost needless*.

Television even shows the past; the B.B.C. last month televised the discovery

of chloroform, and the *Lancet* expressed a physician's "lively apprehension when the dope was inhaled in the sitting posture. * * * The impression was rather like that of a souvenir postcard of a classic picture."

NOVEL "DODGES" IN RADIO

RUDY VALLEE last month proposed traffic signals for mikes—red when the performer is too far away, green if too close, white while just right. But, while waiting to develop this, N.B.C. built a fence around the mike for radio thespians.

Programs for farmers while at work, as well as for farmers' wives, were proposed by John P. Hutchinson, Kansas publisher, seeking a station license last month. "Most farm tractors," said he, "are now equipped with radios or soon will be."

Bone conduction hearing aids are being perfected for pilots, the Bureau of Air Commerce announced last month. Not that pilots' hearing is defective, but change of air pressure with altitude, and crashes of static, occasionally lower the sensitivity of the best ear, says Rogers Humphreys of the safety division, who is working it out.

That soothing radio music brings more milk from contented cows, has long been suggested. At St. John's college, Annapolis, college dietician Georgia Smith last month installed a radio set in the dining hall to slow down the tempo of eating to a Fletcherizing basis.

Radio announcer at KFRO, Longview, Tex., broke a record last month. He



(Globe Features)

The television camera of the British Broadcasting Co., visiting a film studio at Pinewood, near London, to pick up stars for a sight broadcast showing how films are made. Maurice Chevalier, looking congenial. Public interest in these outdoor "spot" television broadcasts has stepped up considerably.



(G.E. photo)

A new studio gadget (which can be used to advantage at conventions, etc.) reminds a speaker when his time is nearing an end. It is operated by the time switch shown in the circle, and sets up to 30 minutes; warning 2 minutes before and at the end.

IN REVIEW

Radio is now such a vast and diversified art it becomes necessary to make a general survey of important monthly developments. RADIO-CRAFT analyzes these developments and presents a review of those items which interest all.

was tired of hearing "Down Among the Budded Roses" and smashed the disc before the mike, to give point to statement that this was posolutely the last run-off.

NOTES OF RADIO RECENTNESS

THE F.C.C. last month announced a policy of protecting the frequency of 455 kc., at the request of the R.M.A., in order to minimize interference with I.F. sections of superhets.

A German court last month ruled that a radio receiver is personal property, like a toothbrush, and cannot be taken for debt. The government has just brought out its new "People's Model" at 65 marks (\$26) and its purchase will be officially urged on every Nazi.

Copper & Brass research association has been counting turns, and announced last month that one radio plant alone uses 15 billion feet of copper wire—enough to reach to the moon and back 5 times—and another 10 million feet (across the U.S.) of brass tubing in radio tubes in a year.

Marconi died, if not poor, not rich, stated David Sarnoff on his return from Europe last month. His estate did not exceed \$150,000.

Japanese competition is worrying the British, said correspondence of the *Times of India*, Bombay, last month: "Two-valve (tube) sets have reached this country for sale at the incredible price of 15s (\$3.70). Fortunately for the British manufacturer, the sets seem to be most unreliable and there is no

prospect of servicing these receivers!"

"Radio detectives prepared wave-traps" said a press dispatch from Philadelphia last month, for a phantom announcer who interrupted police broadcasts with an unknown transmitter. (Not to tune him out, but to tune him in.) In Europe, governments are even more troubled by pirate stations with anti-dictatorship propoganda. In the Ukraine, radio operators were charged with treason last month, for playing "mournful music" after announcing the latest purge.

NEW ANTENNA TO MULTIPLY FIELD

KDKA, which began systematic broadcasting on election night, 1920, last month completed the new antenna equipment, and the anniversary was celebrated (a couple of days early) on October 30. It is a double triumph for Dr. Frank Conrad, who sent out those first election returns; for the big antenna carries out an idea which he had in 1929, but which was unsuccessful at that time. The great self-supporting steel mast, 718 feet high, is a $\frac{3}{4}$ -wave antenna; it is broken at the 336-foot level, and different voltages are fed to the upper and lower sections, so that current flows in the same direction in both, instead of reversing. Around the mast, 504 feet away, are 8 wooden masts each supporting—and this is a novel feature—a "suppressor" antenna. These buck the "skywave" from the main tower, and thus prevent fading and

(Continued on page 435)

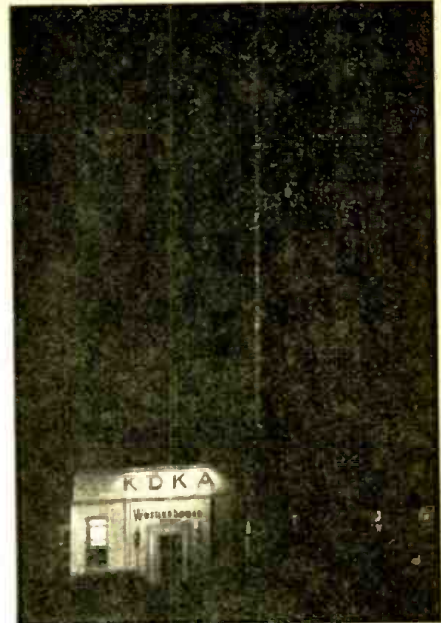

The tall streak of light is the 718-foot antenna mast of KDKA in the glare of searchlights. It weighs 40 tons and rests on a socket in a large porcelain insulator.



Laying 50 miles of copper wire which is an unseen factor in the efficiency of the new KDKA antenna; it is buried about a foot deep, to form a ground. In the background, masts of KDKA's multiple system.



(Phileo photo)

Problems of sound engineering drive radio designers to a padded cell. This, in a Philadelphia laboratory, is padded with tons of "rock wool" which shut out sounds and prevent echoes. The silence, it is said, is actually painful!

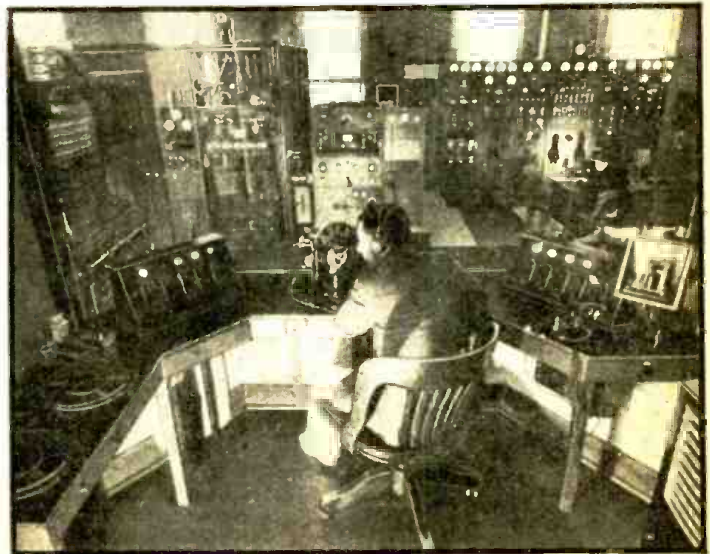

(Westinghouse photo)

Looking from the control room at the transmitter of KDKA, now located at Saxonburg, Pa., the 17th anniversary of whose original faint broadcasts was last month celebrated. A tenfold increase in service area is to be obtained with the new antenna.



700 WATTS
ON 3 METERS

Fig. A

SHORT-WAVE

An unconventional review of progress in the short- and ultra-shortwave fields during 1937; and a challenge to amateurs to continue experimentation towards a lucrative goal.

SPEAKING of short waves—and remembering that amateurs discovered the globe-girdling properties (see Fig. 1A) of these, as experts at that time termed them, “impractical” waves—one is led to believe that a lack of academic wisdom well may be counterbalanced by a liberal portion of common sense.

Ample proof for this conclusion lies in the fact that very few of the fundamental pioneer achievements in the radio field have been contributed by professors. This fact is important, not so much as a matter of pure record, but as a tempting invitation to *practical* men to explore the realm of ultra-shortwaves.

Experimental equipment for exploration in the region below, let us say, 10 meters, and especially in the “micro-wave” region below 1 meter, is relatively simple—employing, as it does, equipment no more complicated than that used in the “crystal detector” days of radio—and inexpensive. Research made today with even the most elementary equipment may tomorrow bear fruit of great value; the humble experimenter may then leave it to the research men to make simple discoveries over into more complicated *but also more efficient* devices.

100-KILOWATT SHORT-WAVE STATIONS

An excellent example of such “efficient complication,” of an initially simple set-up (such as shown in Fig. 1A), is that which we represent in Fig. 1B. This figure illustrates the present trend toward increased output power of short-wave stations to 40, 50 and, in a short time (according to reports from reliable sources), even 100 kilowatts.

Old-timers will probably remember that, some 15 years ago, learned professors dwelled on what little power was required to link the world by short waves. Practice, however, has proven that these calculations were not 100 per cent correct, since a great deal of power is required to secure a *permanent* link of communication under adverse atmospheric conditions.

Are Short Waves Uneconomical? This evolutionary increase in power seems to be iron-clad proof that commercially practicable short-wave transmission possesses no economical superiority over other types of radio communication. But it only *seems* so. We of course need a certain initial output-power to reach the desired party on the other end *at all times*. However, and as we shall see, short-wave communication will not always remain the money-eating affair it is at present.

MANY PROGRAMS ON 1 CHANNEL—SIMULTANEOUSLY!; OR “MULTIPLEXING” A 4-METER POINT-TO-POINT PHONE LINK

As long as we look at short-wave channels as “1-lane roads” they will apparently have little superiority compared with other wavebands (aside from the difference in coverage and range). But we have interesting precedents on hand which indicate that the *present method of utilizing the short-wave-band is already to be considered old-fashioned!*; and it will not be long before a number of completely-different programs, by means of “multiplex modulation,” will travel via 1 single short wavelength to the listener, as visualized in Fig. 1C. This trend is of great importance for all interested in the reception of far-flung short-wave stations.

At present one must patiently listen for hours to a mediocre jazz orchestra, for example, in order not to miss the beginning of an outstanding program of high entertainment value—a symphonic program, let us say. In time to come, one will be able to “slice” from the particular wave-

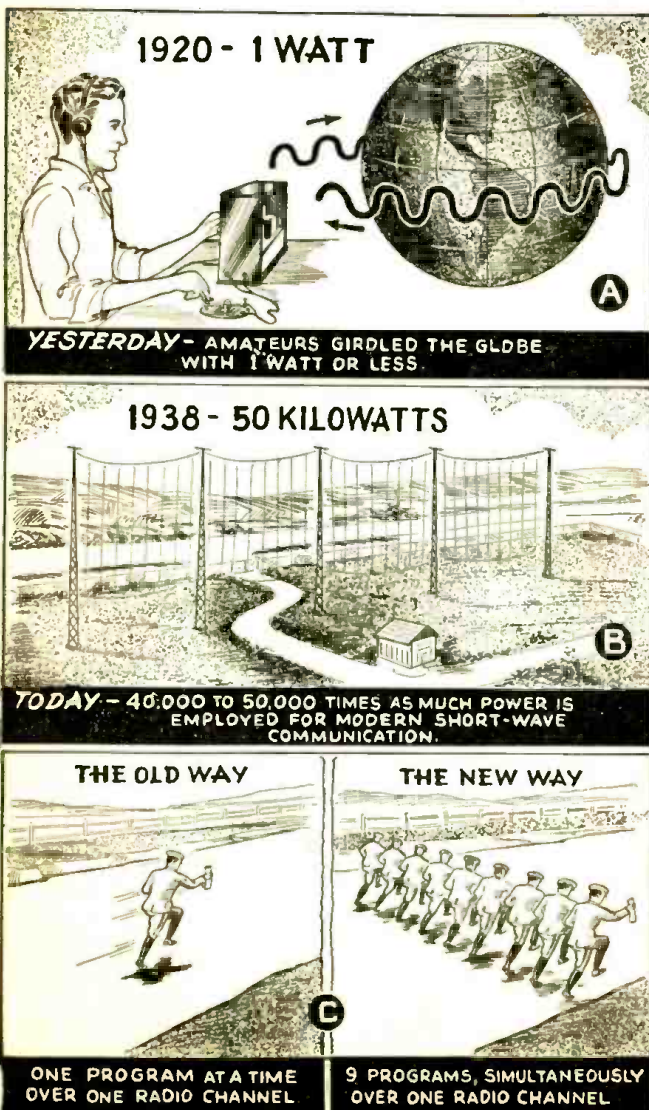

Fig. 1

RADIO MARCHES ON!

W. E. SHRAGE

length to which our receivers are tuned just the individual section of the wavelength which carries to us the symphonic program, and to disregard the jazzband (lecture, etc.), or any one of perhaps 5 to 10 other programs.

9 Phone Calls over 1 Short-Wave Link. This all sounds like fiction à la Jules Verne but it is already far beyond the experimental stage, as a recently-installed dual-wave (76 and 86 megacycles) ultra-shortwave link between Stranraer in Scotland, and Belfast in Ireland, demonstrates. See Fig. 2A. However, this "multiplex" method of modulation is not restricted to the ultra-shortwave range only; it may be applied to the customary short-wave channel but not to the same extent since bandwidth allocations in the short-wave region do not cover as great a frequency range as those in the ultra-shortwave region.

Short-Wave Stations Waste Their Bandwidth. Let's keep in mind that, while our broadcast stations on the 200-550-meter range operate with a band-width of 5,000 cycles (or, counting both sidebands, 10,000 cycles), present short-wave stations operate on a channel width many times greater.

Curtailing the bandwidth of short-wave stations and redistributing the channels at present in use is one solution for satisfying the appetites of all nations for more short-wave channels.

A second method of channel allocation, and one which will arouse less objection from the "have" nations (as compared to the "havesnots") is for the present owners of the most important channels to utilize their wavelengths for double- or even triple-program transmissions. Proof of what can be accomplished is right here before our eyes, namely, the English example mentioned above. The Standard Radio engineers not only transmit simultaneously 9 phone calls over 1 channel but also *scramble* the 9 calls at the transmitting end in order to prevent interception; and separate the speech-impulse mixture at the receiving end!

Change in Design of Short-Wave Receivers Predicted. This change in the method of short-wave transmitter modulation will of course cause quite a number of changes in the customary design of short-wave receivers (Fig. 2B). Probably more selective circuits will be used in the future, and some means to add missing sidebands or carrier waves will be applied. These changes will probably cause protests from various quarters, but what of it? Radio, still a new *art*, is far from being a maze of frozen doctrines (a *science*).

Having assimilated some of the problems, and their solutions, in the short-wave broadcast and communications field let us now analyze television's progress during 1937.

CHANNEL TROUBLE HINDERS TELEVISION PROGRESS

An extremely interesting development in the field of short waves is the fact that television engineers now complain that development of *short-wave transmitter* technique is lagging (see Fig. 2C, that shows us this "bottleneck" which is holding back television progress). An eminent European television expert (Mr. R. Urtel, of the Telefunken Co., who recently visited the author) pithily described the present state of development about as follows:

"Television transmitter design is lagging far behind, yet the technique of television image pick-up and reproduction will develop shortly to such a degree that we will not know what to do with it. The reason for this seeming paradox is, 1st, lack of transmission channels wide enough; and 2nd, lack of transmitters which will permit a powerful signal to be radiated from the highly-developed television pick-up camera to the equally well-designed television receivers."

(Continued on page 426)

SOME OF 1937'S DEVELOPMENTS FEATURED IN THIS ARTICLE—

- 9 Programs on 1 Wavelength
- 731-Line Television
- The "Bottleneck" of Television
- Super-Power Tube for Decimeter Wavelengths
- Steerable Anti-Fading Short-Wave Antenna
- Standing-Wave Transmission Line for Simultaneous Duplex Transmit-Receive Operation

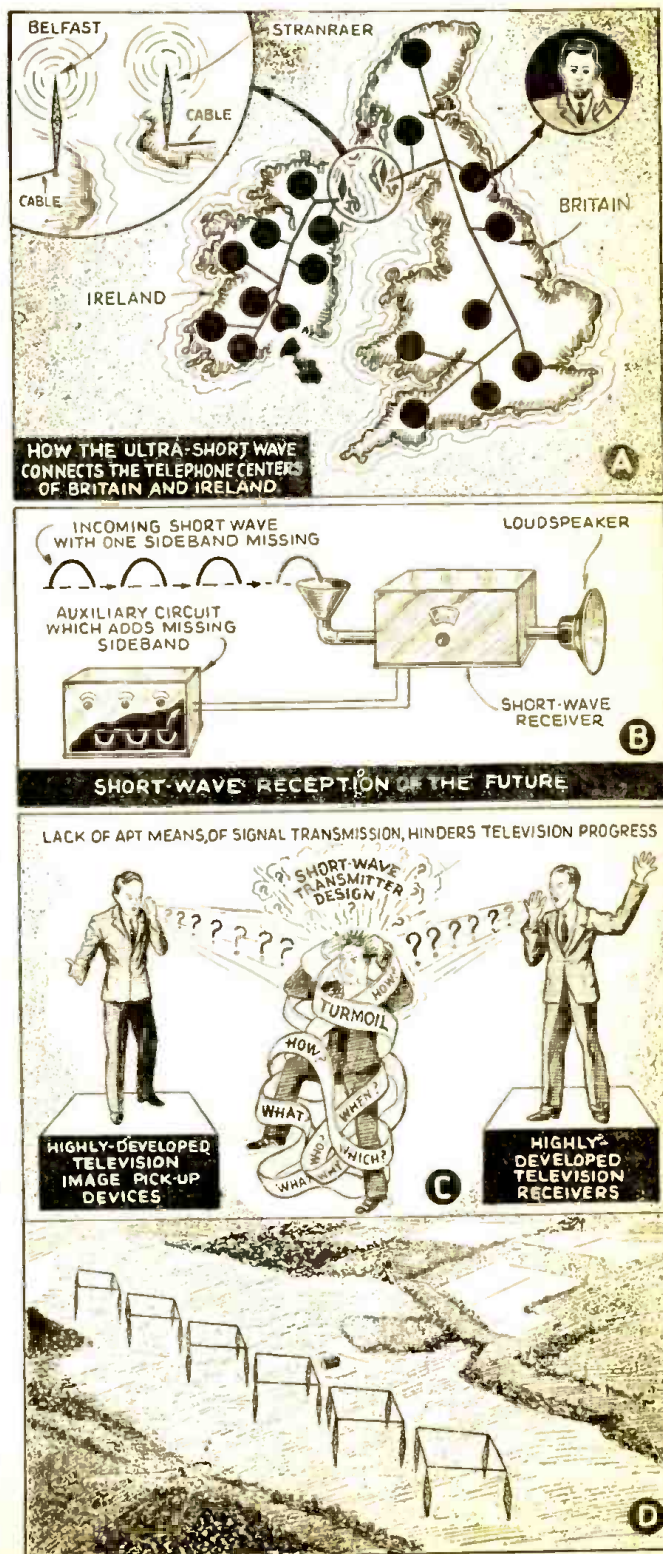

Fig. 2.

RADIO IN PICTURES



(Globe photo)

Here you see the newest addition to the communications equipment of England's Royal Corps of Signals. This 1-man portable radio station, here shown during an inspection at Men's Barracks, Aldershot, both transmits and receives; the directivity that the loop antenna affords permits obtaining maximum efficiency with minimum power consumption.

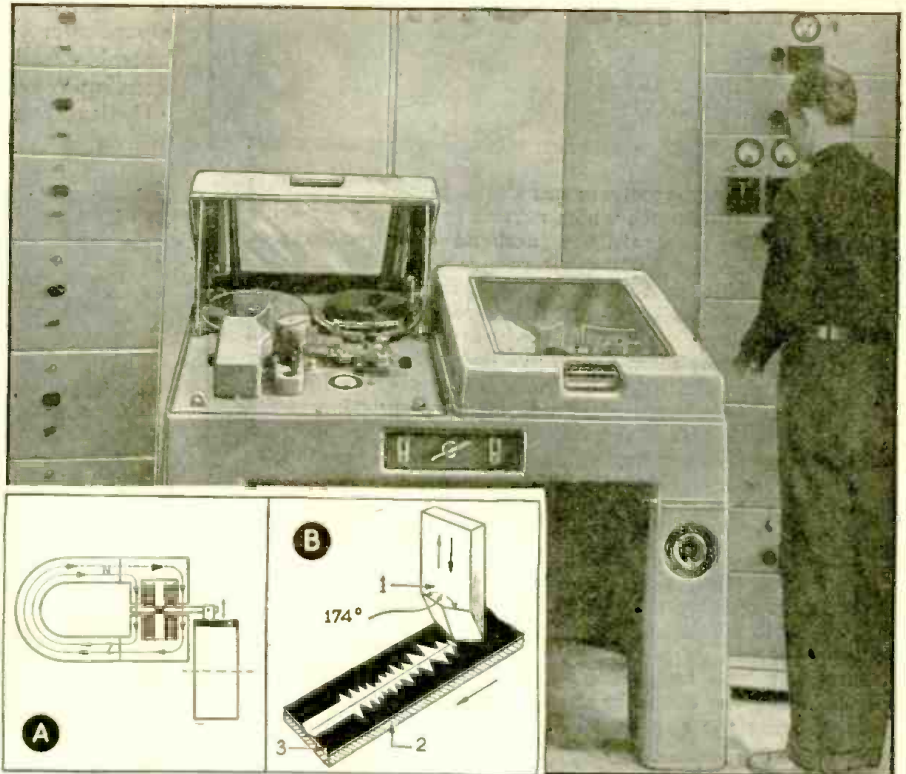

(Shrage photo)

At short-wave station PCJ in Eindhoven, Holland, a 2-unit sound recorder and reproducer—the Philips Miller system—is used to *electromechanically* record programs and, almost simultaneously, *photo-electrically* reproduce them on short waves. Insert-detail A shows how the recorder is made; at B, a close-up of the cutting tool of the recorder. The cutting knife, 1, its working edge sharpened to an angle of about 174°, cuts into a translucent-celluloid ribbon, 2, which is covered with an opaque layer, 3. The knife thus cuts a triangular groove; and, cutting more in horizontal than in vertical direction, cuts a wider track for strong impulses. The resulting, partly-translucent film may then be immediately played-back, by utilizing photocell pick-up equipment, without the usual developing, washing, etc.

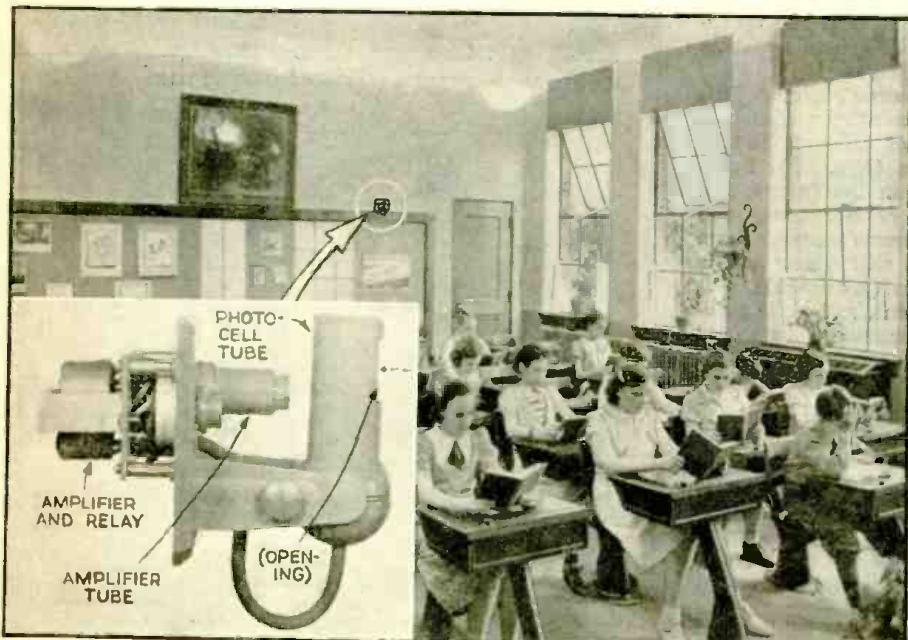

(General Electric Co. photo)

Electric "eyes" now afford mass protection of human eyes by automatically controlling an East Cleveland, Ohio, schoolroom's lighting. The main control unit is shown, inset, above. Natural light coming through the window falls on a light-sensitive tube. Any difference in the amount of light striking the photocell produces a current change that is amplified and, if either extreme of the pre-determined operating range is reached, operates a relay which either lights or extinguishes the regular illumination of the room. One knob on the control panel determines the light level at which the unit will turn on the artificial light of the room; a second knob sets the level for turn-off. The photocell-tube shield may be twisted, and tube and shield tilted on swivel bearings, to position the shield's light-opening as installation requirements demand. What a harvest Service Men will soon reap servicing these systems in schools—and homes, offices, factories, etc.!

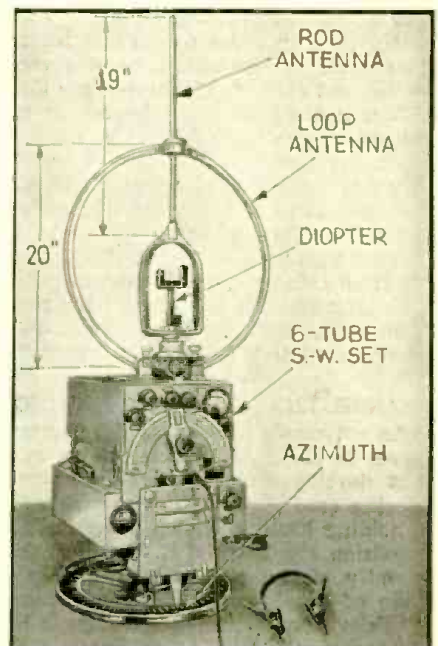

(Shrage photo)

Newest in German Army equipment for survey work and airplane soundings in foggy weather is this telefunken 15 to 100 meter "nahfeld peiler." It incorporates (1) a cast-aluminum, directional loop-antenna, (2) an aluminum, auxiliary, non-directional rod-antenna that penetrates the loop-antenna, and (3) a diopter for optical survey. The 6-tube ultrashortwave receiver, contained in a cast-aluminum case, surmounts an azimuth-circle base.

FLICKERLESS FILM-TELEVISION

Improved means of mirror-drum scanning, together with a cathode-ray pick-up system, now afford flickerless 441-line film-television.

TELEVISION seems to be an accepted fact in Europe, mainly because it is a government-subsidized industry supported by taxes on the use and ownership of radio apparatus. Nevertheless the presentation of television programs, because of their almost prohibitive costs, created a tremendous problem. Consequently television transmitting stations are resorting to transmissions of film and newsreel material for the entertainment of the "lookers-in."

Until recently, however, this procedure introduced the problem of *double flicker*, i. e., the flicker which is normally present in a film projection system *plus that which is inherent in the television image* (caused by atmospheric disturbances, etc.). The resultant effect of both types of flicker manifested itself in an extremely poor and fatigue-inducing image.

Engineers, having very little or no control over atmospheric flicker turned their attention to eliminating the film flicker. As a consequence an entirely new projector (see Fig. A) was designed, with a film carriage which moves along smoothly and continuously, without the customary jerking finger used to project individual frames in the ordinary film projectors. Both film projector and television scanner (using the Iconoscope tube) are built into one integral unit, as shown in Fig. A.

Scanning is accomplished by means of a mirror drum as illustrated in Fig. 1. As shown, the film (A) is moved and illuminated absolutely uniformly. The old flicker as frame after frame of the film is pulled into the light gate by the jerking intermittent sprocket is no longer present. The motion is continuous due to the fact that at the time the mirror of the drum (B) is about ready to finish the scanning of a given frame, the adjacent mirror has already started to scan the following frame. To avoid "cross-over" of the scanning lines, or better said, scanning impulses, the power of illumination of the first operating mirror decreases in the same degree as the brilliancy of the adjacent mirror increases. This increase and decrease of illumination is caused by the oscillating movements of the scanning mirrors.

Figure 2 shows diagrammatically the new continuous projecting system combined with the Iconoscope televising system. The film is sent as customary from an upper drum into the projector. The light from an arc lamp is projected (as the arrow heads indicate) over a system of stationary and rotating mirrors in the center of which passes the film. The projected light, modulated by the subject matter on the film, finally falls upon the mosaic screen (M) of the Iconoscope.

As shown in Fig. B, the amplifier of the Iconoscope is built in the same box to make for shortest possible connections. At first glance this new projector-televisor seems quite complicated but is actually more simple than previous systems inasmuch as a number of moving parts have been eliminated.

This new flickerless system of film-television utilizes the type of high-fidelity television we now designate as "441-line" transmission. The transmitter proper employs "positive D.C. modulation." Figure A shows that the Iconoscope scanner apparatus mounts on top of the remainder of the projector equipment. Its containing box is made of aluminum with compartments subdividing the interior as shown in Fig. B; as this figure shows, coils are used to produce magnetic deflection of the flying electron spot that picks up the image voltages developed photoelectrically on the Iconoscope screen (a mosaic comprised of myriad light-sensitive elements of microscopically-small proportions).

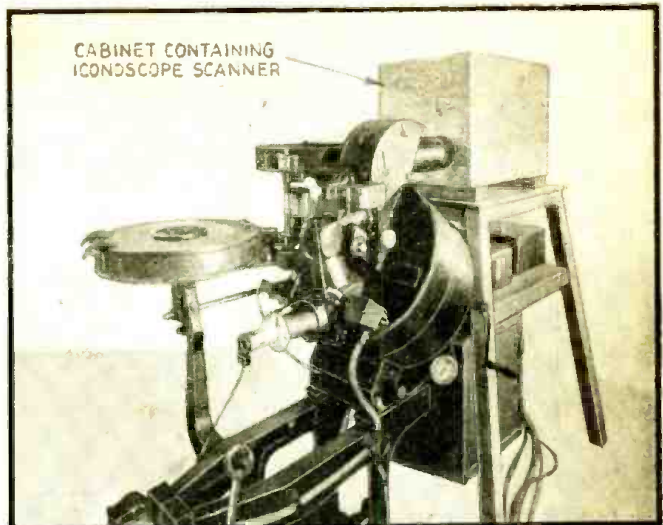

Fig. A. This newly-developed European television projector-scanner contains a film carriage that has a continual motion instead of the intermittent motion of ordinary projectors. This design eliminates film flicker, resulting in a steadier television image. The box at the right houses the Iconoscope scanner and its amplifier.

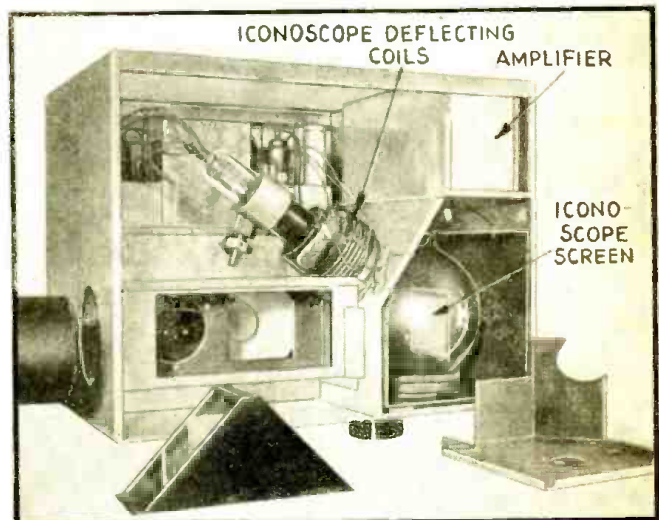

Fig. B. Close-up of the Iconoscope cabinet on top of the new projector-scanner. The amplifier is built-in, close to the tube, to make for short leads.

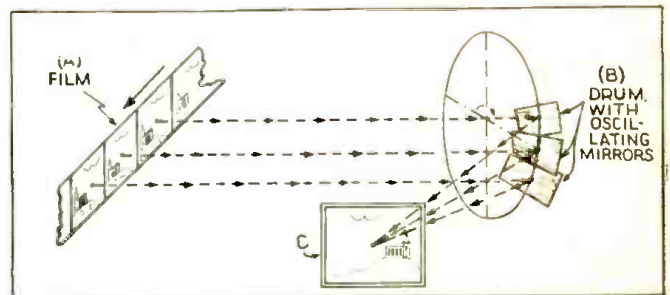

Fig. 1. Sketch showing how the film, which is moving continuously (not intermittently, as is usual) is scanned to produce a flickerless image.

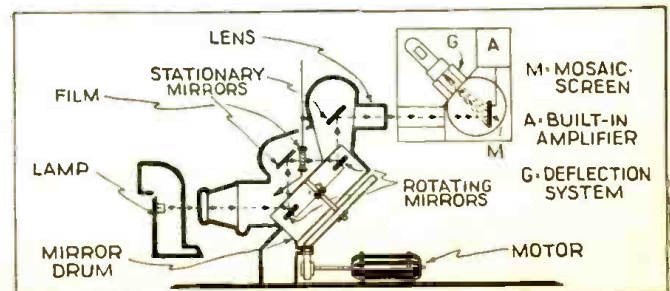

Fig. 2. Sketch of the new projector-scanner showing clearly the entire mechanics of operation.

HOW TO MAKE "SHORT-WAVE

The operator of amateur radio station W2FHP, in cooperation with Donald Lewis, describes a novel superhet. with "Magic Eye" 2nd-detector. Beginners may follow the pictorial diagram. Despite its novel feature of utilizing an "eye" for dual service this S.-W. receiver is thoroughly practical.

HOWARD G. McENTEE

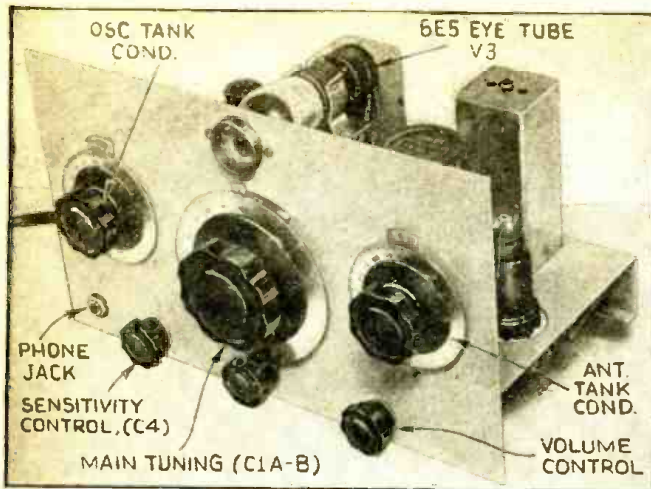

Fig. A. The neat appearance of the "Short-Wave Special." On the higher frequencies the main tuning dial affords excellent bandspread.

THERE IS ALWAYS a field for a small, inexpensive all-wave receiver that may be made by the Ham constructor. Such a set must be simple but efficient; it must be easy to "line-up" without the necessity of using a test oscillator.

The little receiver described here ably fulfills these requirements. It is quite straightforward in design using a simple superhet. circuit with only a few departures from the usual. A system—the simplest type—of bandspread is used which makes it unnecessary to employ variable padding or trimming condensers. (See Fig. 1A for the schematic circuit.) The use of parallel tuning makes it easy to line the detector and oscillator circuits on any band.

CIRCUIT FEATURES

Iron-core I.F. transformers provide a high order of gain for the single I.F. stage used. This gain can be increased even higher by the use of the *regeneration control* which is connected from the plate of V2 to the plate of V3. When advanced to the point of oscillation, the receiver is able to pull in C. W. ("continuous-wave" or code) signals. It may be necessary to reverse the connections to the primary of I.F.T.2 in order to obtain regeneration and oscillation in the 2nd-detector, V3.

The greatest novelty of the set is the use of a 6E5 as 2nd-detector. (See Figs. A and C.) Such use for this tube was described in the May 1937 issue of *Radio-Craft* (in an article titled "Build 'The Cyclops', A Beginner's 1-Tube Set") and the tube was found to be an exceptionally efficient detector. This use provides a certain amount of tuning-indicator effect on the fluorescent screen of the 6E5, although of course the action cannot be compared to that obtained in a receiver incorporating A.V.C. Nevertheless, a moderate carrier will cause a noticeable deflection. The "eye" also acts as an indicator pilot light.

Plug-in coils are used since they are simple and efficient.

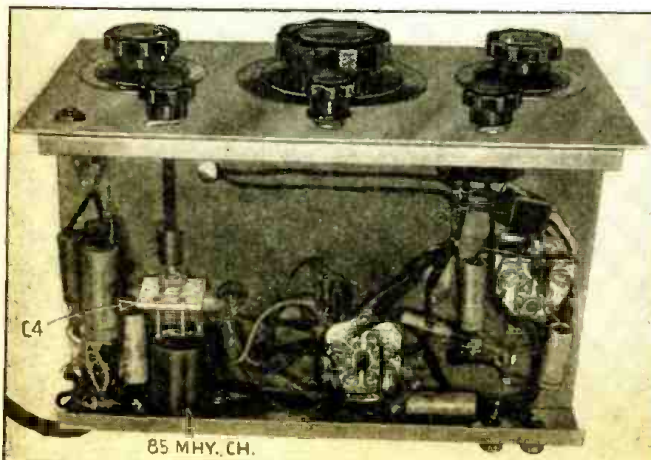

Fig. B. Under-chassis view showing the wiring and placement of parts.

A ready-made set of coils is listed but slight changes must be made in some of the windings. Figure 3 contains all the necessary coil information. Although only 2 windings are required on each coil, the factory-made 6-prong coils have 3 windings. The winding on the bottom of the coil is not used and is disregarded, although it is not necessary to remove it. If the coils are home-wound, only 2 windings need be put on.

No broadcast band coils are mentioned, but the largest coil of the set covers a considerable portion at the high-frequency end of the broadcast band. Another set of coils is needed to cover the remainder of this band.

CONSTRUCTION

Construction is started by drilling the panel and chassis according to the specifications given in Fig. 2. It is possible to buy a steel chassis of the dimensions shown, but aluminum or electralloy is much easier to work with. After drilling, the original panel and chassis were given a coat of French gray duco enamel. This serves to cover any scratches on the metal.

The 2-gang main tuning condenser is fastened by its shaft nut to the front panel. Also a screw holds it steady to the chassis at the rear.

The tube sockets are mounted below the chassis while those for the coils are set up on the bushings provided and mount above the chassis.

The 35-mmf. regeneration condenser is mounted by its bracket beneath and to the rear of the chassis, and is controlled by a bakelite shaft from the front panel. Note that the mounting bracket must be set up on insulating washers since both sides of this condenser are above ground potential.

The 6E5 socket is held by a bracket from the front panel. If a manufactured assembly is used to mount this tube, it will be necessary to remove a small resistor usually found in these units connected from the plate to target prongs. Also a lead should be brought out from the plate prong. All the leads from this socket are bunched and run through a piece of shielding to the underside of the chassis.

The first point in putting the set into operation is to make sure the regeneration control on V3 works properly. Next check for I.F. alignment. If a vacuum cleaner or electric fan is in operation the all-wave brush-static may be heard and can be used to line up the 4 trimmers in the I.F.T. cases! Do not touch the trimmers, before first listening-in, as they are set at the factory to the proper frequency. After the noise is heard the final trimming for loudest response may be made.

Now rotate the two 140-mmf. condensers very slowly until a signal is heard, then turn the oscillator dial to the lowest of the 2 points at which the signal can be picked up. These 2 points will be found quite close together on the dial and the one received when the condenser plates are farthest out is the correct point. Once the 2 small dials are set the main tuning dial will give fine tuning or bandspread over a portion of the band. The bandspread becomes increasingly important as the frequency goes higher. When tuning in the

THE 4-TUBE SPECIAL

Beginners—build this receiver. This regenerative S.-W. radio set covers the range of 10 to 20 and 17 to 270 meters, and may be used either for amateur radio reception or for broadcast program reception (within this wavelength range). Bandsread action makes short-wave tuning easy; especially, since weak stations may be tuned-in by means of the zero-beat method. The type 6F6 tube affords a power output of about 3 W.—ample for ordinary loudspeaker reception.

AND DONALD LEWIS

lower-frequency bands, the 140-mmf. condensers will be found more convenient.

Any power supply capable of supplying 6.3 V. at about 1.5 A. and 250 V. at 50 ma. may be used, as may batteries. Any type of loudspeaker or phones may be used since no D.C. passes through them. If, instead of batteries, an A.C. power supply is used, it should be as hum-free as possible. This goes for noise, too. A power pack designed for broadcast receiver work may not be sufficiently filtered for short-wave receiver operation since any residual hum will be easily picked up by the receiver especially when it is operated near or at the point of regeneration.

An aerial 50 ft. long and as high as possible will enable the builder to get good results from this "baby communication-type receiver." Beginners will find the picture diagram easy to follow.

LIST OF PARTS

- One Hammarlund set of coils, No. SWK6;
- One Hammarlund set of coils, No. SWK4;
- One Hammarlund coil, No. 40;
- One Hammarlund coil, No. 60;
- One Hammarlund tuning condenser, No. HFD30X 30 mmf.;
- Two Hammarlund tuning condensers, No. HF140, 140 mmf.;
- One Hammarlund tuning condenser, No. HF35, 35 mmf.;
- Three Hammarlund octal sockets, No. S8;
- One Hammarlund 4-prong socket, No. S4;
- One Hammarlund 6-prong socket, No. S6;
- One Hammarlund choke, 85 mhy.;
- One Hammarlund iron-core I.F. transformer, I.F.T.1;
- One Hammarlund iron-core I.F. transformer, I.F.T.2;
- One "tuning eye" panel socket;
- †One 4-in. vernier dial;
- †Two dials, 2 1/4 ins.;
- One RCA type 6A8 tube;
- One RCA type 6K7 tube;
- One RCA type 6E5 or "magic eye" tube;
- One RCA type 6F6 tube;
- Four Solar mica condensers, 0.001-mf.;
- One Solar mica condenser, 0.005-mf.;
- One Solar mica condenser, 100 mmf.;
- One Solar electrolytic condenser, 10 mf., 35 V.;
- Four Solar tubular condensers, 0.05-mf.;

(Continued on page 434)

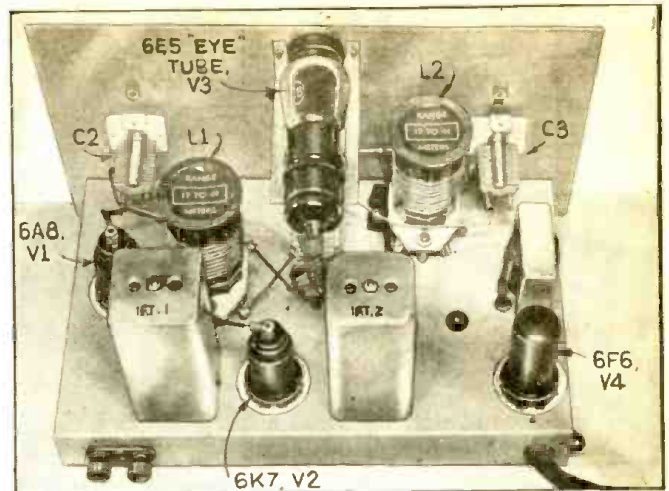

Fig. C. Rear view of the receiver. Plug-in coils afford a simple and efficient means of changing bands.

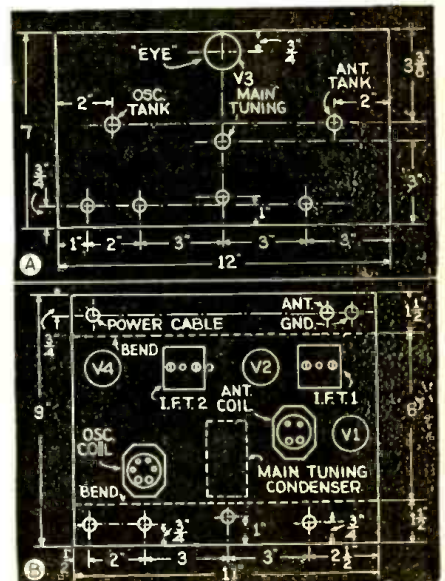

Fig. 2. Specifications for making (A) the front panel, and (B) the chassis.

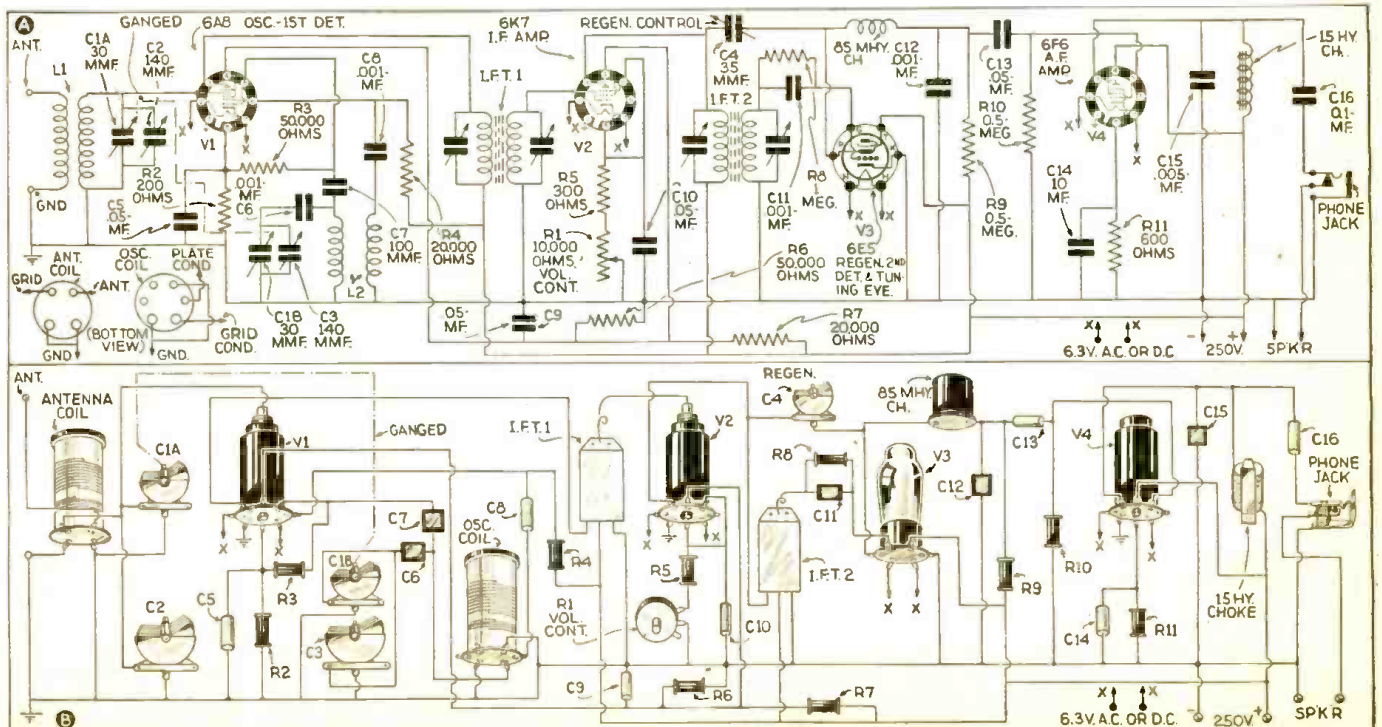

Fig. 1. In A, the schematic diagram and, in B, the pictorial diagram of the 4-tube "Short-Wave Special" receiver. The 6E5 acts as 2nd-detector.



SHORT-WAVE RADIO FOLLOWS THE RACES!

Service Men should read between the author's lines and see how increased "BCL" interest in radio programs—especially "spot" programs—means increased service business.

N. H. LESSEM

BROADCASTING, today, presents a more living image of life in America than does any other single medium. Perhaps the most outstanding contribution to personalizing the programs we hear is the "spot" or remote pick-up.

As the cover illustration of this issue of *Radio-Craft* indicates—and as reproduced on this page—spot broadcasting takes you right to the scene of greatest action. Studio programs lack the spontaneity, the verve, the sparkle of life, action and the joy of living we find in the remote pick-up.

Whether, as depicted in the illustrations mentioned above, it's an outboard motorboat cutting the spray with the best of them while a broadcast network

announcer brings to you the second-by-second progress of a hotly contested race of "outboards"; whether, as occurred last month, the announcer takes you into the hold of a submarine, while it executes a sham "crash dive," and aurally paints a picture of coordinated action at lightning speed, under water, as the submarine launches torpedoes at the "enemy"; or whether the magic carpet of radio's spontaneous broadcast has transported you to your good neighbor a city or two away, while you hear him, in a "Wandering Microphone" remote pick-up program, it's always the pulsing, surging reality in American life you experience.

The year 1937 closes on spot broadcasts that will continue for many years in the memories of millions of broadcast listeners. Broadcasts that represented thousands of dollars—thousands of sleepless hours testing and re-testing

equipment and set-ups, arranging for vantage points, obtaining permits and rights-of-way, and all for a few seconds or minutes of entertainment. Spot broadcasting has crammed into one year a wealth of entertainment, knowledge and action, for the intelligent radio listener, unequalled anywhere else in the world by any other medium. Unfortunately, not every radio set owner is a "good listener"; preferring to take his programs haphazard, many listeners-in miss the really choice programs, the delicacies, that technicians labor months to prepare for a given few moments on the air.

But wait! 1938, and succeeding years, are ahead of us. Resolve now to more closely watch the programs in your daily newspaper. Travel, visit strange lands, virtually "see," through the eyes of expert narrators, new people, new

(Continued on page 444)

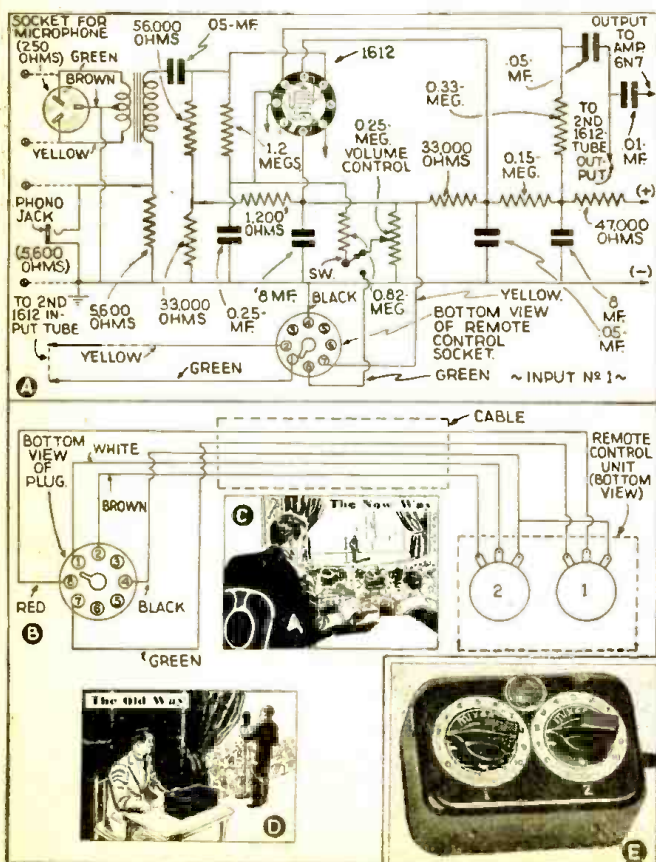

Fig. 1. A—the remote control unit connects to the amplifier by means of a cable; B—input channel; C and D—new and old P.A. control methods; E—the control fits the hand.

REMOTE MIXING ACCOMPLISHED IN LATEST P.A. SYSTEMS

Use of the new 1612 Pentagrid Volume Control Tube makes possible remote mixing and volume control in Public Address systems.

IN ORDER TO realize the most effective and most pleasant reaction by an audience to a P.A. system it must be constantly "monitored" from a point of vantage in the audience. This, of course, calls for a remote control system of "fading" and "mixing" the input circuits of the amplifier.

Until the present time, however, such a system was impractical due to the difficulties introduced by the distributed capacity of the long cables, etc. Now, however, it is possible to accomplish this remote mixing, up to 2,000 ft. from the amplifier, through the medium of a compact portable unit (shown in insert E, Fig. 1) small enough to be held in the hand. This of course is a highly desirable feature, never previously offered in P.A. equipment of any type. It has been adapted to the latest public-address systems of a well-known large manufacturer.

NEW 1612 TUBE AFFORDS CATHODE-CIRCUIT VOLUME CONTROL

The amplifiers with which this remote mixing unit is used have 2 separate input channels. Each channel has provision for phonograph and microphone input. *Mixing* of these input channels is not done in the signal circuits but is accomplished in the cathode circuits of the input tubes.

(Continued on page 444)

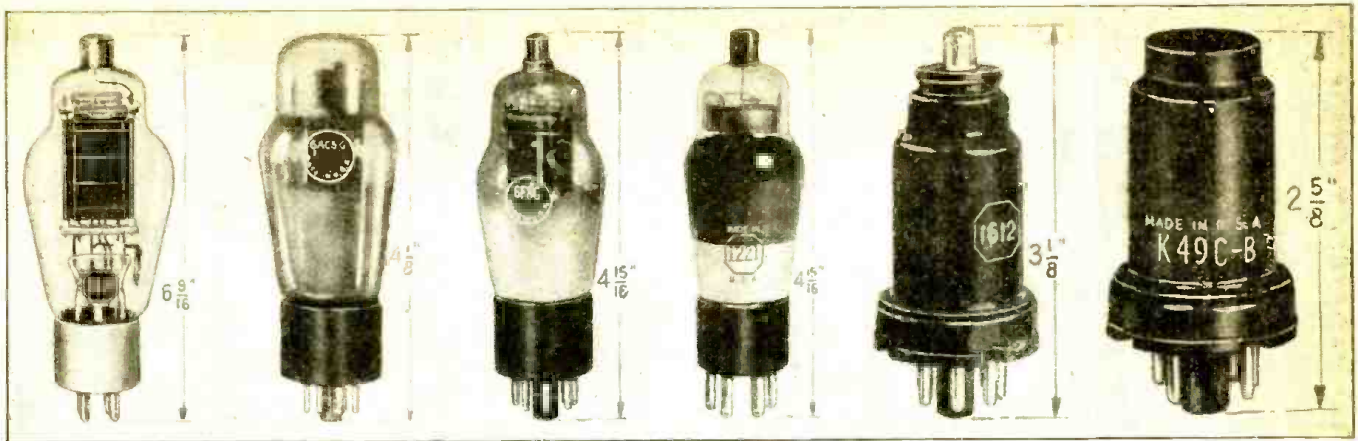

Fig. A. These 6 new tubes fill important positions in the scale of electronic activities. Respective terminal connections are given in Fig. 1.

NEW TUBES

FOR SHORT WAVES, PUBLIC ADDRESS AND OTHER SERVICES

Electronics specialists continue to wage unceasing war against the limitations of existing tube types. This month we learn about several new tubes that hurdle many problems.

R. D. WASHBURNE

A NEW SCHEME is being tried, this month, in the manner of presenting the data on the newest tubes. Instead of including the characteristic data at the end of the respective tube discussion, the discussion of each tube will follow in consecutive order; the tabulations of data then will be grouped at the end of the general descriptions. This will enable the reader to more quickly absorb the essential information concerning the service for which the tube was designed. Then, if the reader desires to study the tube's operational data more closely, reference may be made to the characteristics tabulation. (Curves are available from the respective manufacturers.)

SHORT-WAVE TRANSMITTER TUBE

809 R.F. Power Amplifier, Oscillator, and Class B Modulator Triode. The 809 is a 3-electrode transmitting tube of the high- μ type for use as a (1) radio-frequency amplifier, (2) oscillator, or (3) class B modulator and (4) audio-frequency amplifier. (See Fig. A; terminal connections are given in Fig. 1.)

Because of its high *perveance* (one figure of merit used in connection with tubes designed for transmitting service),

the 809 can be operated at high plate efficiency with low driving power. The plate connection is brought out through a separate seal at the top of the bulb to provide high insulation. The internal structure of the 809 permits operation of the maximum ratings at frequencies as high as 60 megacycles. The maximum plate dissipation is 25 watts for class C telegraph and class B services.

The 809 is equipped with a ceramic base. This tube is preferably mounted vertically with the base down; or, if it becomes necessary to mount it in a horizontal position, the tube must be placed so that the plate is vertical or "on edge." Operate the filament within ± 5 per cent of its rated voltage. To avoid puncturing the glass envelope, due to peak-voltage effects, nothing should be permitted to touch the glass. With the grid connected to the plate through the shortest possible connection, the resonant frequency of the grid-plate circuit is approx. 140 megacycles. To prevent strain on the plate connection this (cap) terminal should be connected into circuit only by means of a flexible lead.

Characteristic data for the several types of service in

(Continued on page 432)

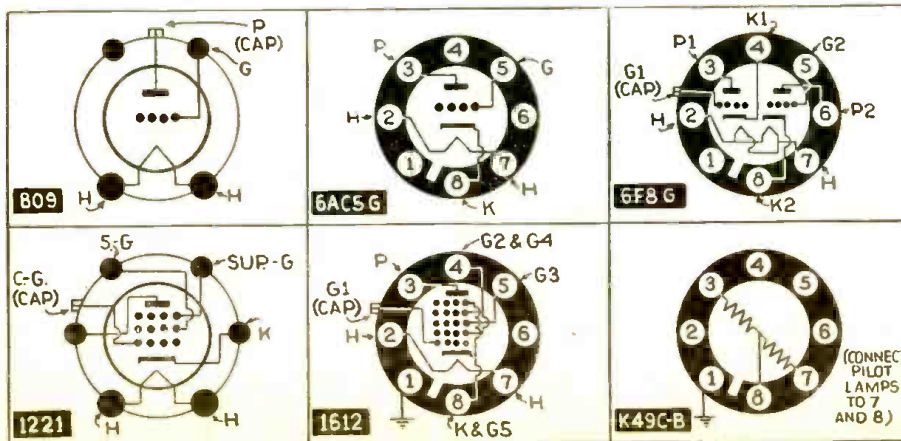

Fig. 1. Although the symbols are somewhat conventional the characteristics differ widely.

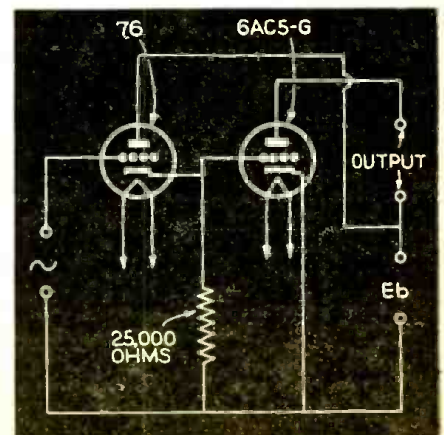

Fig. 3. "Dynamic coupling" circuit of 6AC5G.

FUN WITH RADIO

The operator of amateur radio station W2GY breezily describes novel ideas that any short-wave enthusiast may easily duplicate. All these ideas have been tried out.

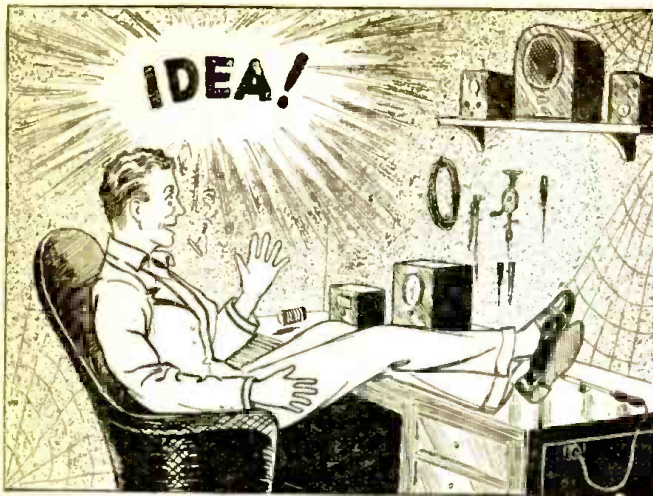

Fig. 1. Socko!—A bright young OM gets an idea on how to enliven the Ham-radio hobby. Soon the old cobwebs will be dusted away and the "rig" will be perking once more; but along new lines.

MANY A RADIO AMATEUR has found himself at that point where even the thought of winding another coil or calculating another resistor value, makes him wish that he had never even heard of "Ham radio." Unmolested, the spiders build webs among his transmitter's coils and dust gathers on the cover of his log book, for he knows that a "Hello CQ" will bring forth "just another VK" or else, just another cut and dried QSO beginning with the time worn "The rig here is . . . etc." and ending with the equally use-frazzled, "Sure glad to have worked you, OM" etc.

WHAT TO DO?—AND WHY

What to do? Give up Ham radio as a hobby? Sell all the "junk" and forget all about the whole darn business? ("Heh, heh!" chuckles the Old Timer, "Try and do it!") Why contemplate such things, OM? There's still a lot of fun left in Ham radio even if you only work a mile or two instead of the thousand or so that you're used to.

Why not forget all about such things as DX with its attendant headaches of trying to work that elusive 2½-watter in the wilds of Megoravia or the constant sand-paperying of your mental cells worrying why the "Q" of some carefully-designed coil and condenser combination always insists on landing some 18 miles due South-West of its equally (you think!) carefully calculated value! Let the DX fall to whom it may for awhile. Hide the sliderule and push the oscilloscope 'way, 'way back on the closet shelf. Find yourself some equally "disgusted with the whole darn business" brother Ham and together, read the rest of this article for a few suggestions on ways and means of getting a bit of fun out of your hobby.

If you are a member of a Radio Club or similar group, all the better, for most of the things we are about to describe make excellent programs for club activity. The whole gang will enjoy taking part in them and, in addition, usually some worthwhile and desirable publicity for the club and amateur radio as a whole, will result.

What are some of these marvelous "bring 'em back to life" ideas that we're talking about? Well, take for an example, a few of the exploits of a group of New Jersey amateurs, who found themselves in the position of yourself, bored with DX, tired of local rag chew and filled almost to the blow off point with the "Z over Pi square L" business.

5 METERS WEDS AIRPLANE AND P.A.

One of the group suggested that if they could only find some odd or unusual uses for their equipment, something that was a bit out of the ordinary run of things, that the gang might have their lagging interest renewed.

Finally it was decided that some out-of-door ultra-high-frequency work might be fun. With that for a starter (the boys were well-equipped with portable 5-meter equipment) it wasn't long before someone suggested airplane-to-ground communication as an interesting experiment. Now most amateurs (and this group particularly) seldom have

sufficient of "the necessary" to keep them at the level they desire in their own hobby, let alone owning airplanes, so the main difficulty in carrying out the suggestion was to find someone that *did* own a "sky buggy" and who might be sufficiently non-financially interested to donate its services for the contemplated bit of foolishness.

Within a short time 2 of the more silver-tongued of the group succeeded in interesting the manager of a small local airport in the scheme and, agreeing to conduct their experiments during the summer week-ends, without much difficulty coaxed him into supplying a plane and a pilot as needed.

A medium-power, 5-meter transmitter together with its associated receiver was set up in the airport field office and with surprisingly little difficulty, a small battery-powered transceiver was installed in the passenger's cockpit of one of the planes on the field. The antenna used on the plane was a simple 4-ft. vertical rod clamped to one edge of the cockpit and worked against the metalwork of the plane used as a ground.

Excellent 2-way communication was obtained from this simple set-up and much fun of an interesting and instructive nature was gained by all from the experiment.

With the 2-way set-up working as smoothly as it was, it was not long before, looking for fresh fields to conquer, the operators of the field-office transmitter thought up the idea of rebroadcasting the plane-to-ground transmissions over the airport's sound system for amusement of the assembled crowds. Needless to say this arrangement went over in a big way and several highly interesting week-ends were spent at the field. See Fig. 2.

A 5-METER RIG TEACHES "BLIND DRIVING"

During one of these week-ends, the weather being somewhat windy for much flying, a stunt was arranged as a "crowd thriller." The transceiver was taken from the plane and re-installed in one of the Ham's automobiles. The crowd was told, over the sound system, that a demonstration of "blind driving" was going to be staged. Then, securely blindfolded and provided with a pair of earphones, one of the Hams took the wheel of the car on a tour of the airfield guided entirely by the operator at the microphone of the field-office transmitter.

Several highly amusing situations developed, one, of quite

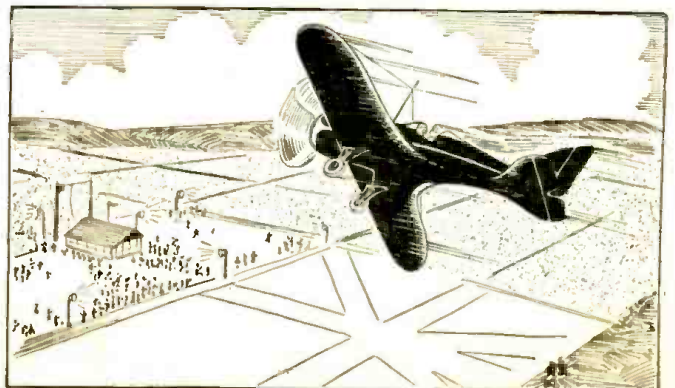

Fig. 2. The Ham in the borrowed "air buggy" is broadcasting with his 5-meter "rig" to a short-wave listener pal on the airfield. The receiver output is connected to the airfield's public address system—and everybody, including the spectators, has considerable fun in the ensuing conversations.

SHORT-WAVE APPARATUS

Mr. Haas arouses the ennuied transmitting Ham to further explore the high-frequency domain; and tempts the merely "listener-in" set owner to participate in Ham activities that do not require all to have transmitting licenses.

.....NELSON G. HAAS

an unscheduled nature, when the car driver found that in a little depression at one end of the field a very complete "dead spot" existed for the field office's signals, leaving him quite on his own—blindfolded!

No transmissions being made from the car, no licensed operator was required, so all present, interested in such "nut ideas" were able to learn how it felt to drive a car "by ear." Several of the pilots present at the field got quite a kick out of this new form of "blind flying." See Fig. 3.

Now these 2 ideas serve to illustrate how easily some real fun can be obtained from short waves without a lot of expensive and complicated apparatus. The ultra-shortwaves offer themselves remarkably well to experiments of this type as the apparatus is simple and generally well adapted to portable use. Many other arrangements, where 2-way communication between some unusual places or points will offer a good deal of fun, are possible with very few technical headaches involved.

5 METERS LINKS HOBBY SHOW AND TRANSCONTINENTAL HAM NETWORK

Another example of the way the ultra-shortwave bands may be used is illustrated by the set-up that a group of Hams had at a Hobby Show held in their High School. Given a space in the auditorium to devote to their hobby, they installed a complete 5-meter radiophone station and arranged a radio link between the school and the home of one of the Hams on the other side of town. Messages from those attending the show were accepted for transmission to all parts of the country and were passed over the 5-meter link to the other station, which in turn transmitted them over the regular amateur traffic networks. A practical demonstration of amateur radiotelephony was thus given to the spectators.

HAM DEMONSTRATION OF "SPOT BROADCASTING"

Later in the show, a demonstration was given of how the large broadcast companies arrange their broadcasts from remote points. See Fig. 4.

This demonstration of "spot broadcasting" was accomplished by having 2 of the boys carry a small 5-meter transceiver through various parts of the school, making contact with the station in the auditorium, which rebroadcast the received signals to the station on the other side

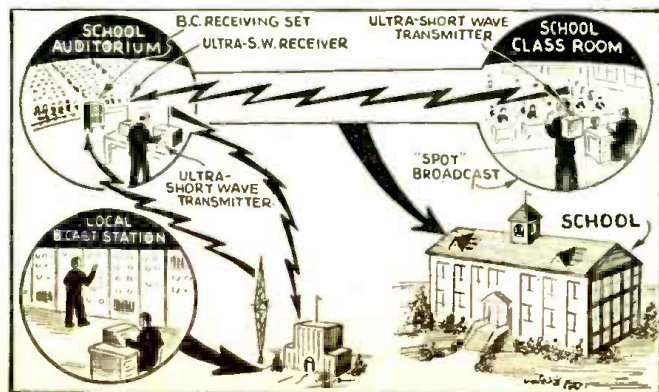

Fig. 4. A couple of OI Timers demonstrate to school students a "spot broadcasting" program. Program pick-up from classroom is relayed to school auditorium, from there to local broadcasting station (or 160-meter Ham), thence back to the regular broadcast receiver in the same auditorium!

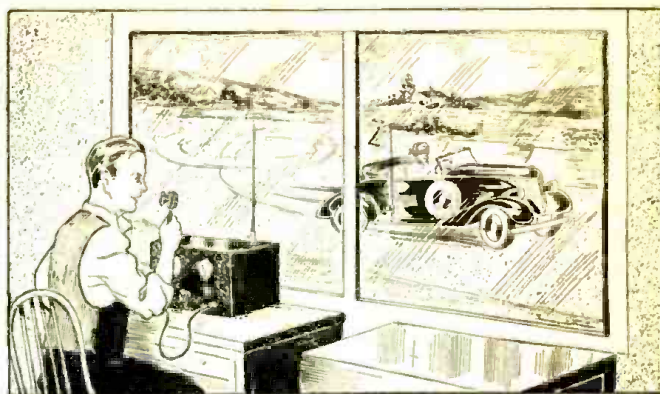

Fig. 3. Another good "crowd-thriller" stunt. A demonstration of "blind driving" on a local airfield by a transmitting Ham and a short-wave listener pal. The blindfolded driver is directed entirely by radiol

of the town. The operator of that station, again rebroadcast the signals over his 160-meter radiophone transmitter and a receiver tuned to his frequency brought the signals back to the listeners in the auditorium of the school. Much publicity for the amateur group was obtained from this hookup.

SHORT WAVES LINK ULTRA-SHORTWAVES FOR 4-WAY "QUADRUPLIX"

This business of rebroadcasting signals from other stations, alone, provides a very interesting field for the experimenter.

Recently, 2 amateurs, operating solely on the ultra-high-frequencies but unfortunately living in cities too widely separated to allow direct communication over their own hands, were enabled to contact each other quite successfully by the cooperation of 2 other amateurs, who operated radiophone transmitters on a lower-frequency band, where the distance could be covered with no trouble!

Each operator of the low-frequency transmitter (160 meters was the band they used) picked up the signals from the ultra-highfrequency operator nearest him and rebroadcast them from his transmitter. The 160-meter stations happening to be operating on frequencies fairly far removed from each other found *duplex operation* quite simple (duplex operation is where the 2 operators may talk together as though they were in the same room, instead of the more common, one-at-a-time method most generally used).

Before long, it was found that a 4-way duplex or quadruplex hookup existed, where both the low-frequency and the ultra-highfrequency operators could converse at will just as though they were in 1 room.

5-METER REMOTE-CONTROL SYSTEMS

Control by radio will offer much of interest and amusement even though but a simple set-up is used. Most experimenters will immediately think that radio control systems are complex and intricate. This is not the case, especially where the experimenter is satisfied with control of 1 or 2 simple operations.

Using Ultra-Shortwave Superhet. Receiver. A relay connected in the plate lead of the intermediate-frequency amplifier of any superhet. receiver having A.V.C. will be operated by the changes in the I.F. tube's plate current due to the A.V.C. action under an incoming signal. This relay need not be one of the expensive, ultra-sensitive kind, either, as the current changes are often 5 or more milliamperes (ample to operate any fairly sensitive, high-resistance relay). An auxiliary battery circuit may be used to operate a larger relay whose contacts are capable of carrying the current of the devices to be controlled and, with this hookup, many and varied are the experiments which may be performed.

Using Ultra-Shortwave Non-Superhet. Receiver. On the ultra-highfrequencies, in instances where superhet. receivers are not used, the relay may be operated by the change in plate current of the audio amplifier tube or tubes, if these tubes are biased into the "class B" region of their curves.

The audio component of a received signal, either tone modulation or voice, will provide the necessary plate swing

(Continued on page 446)

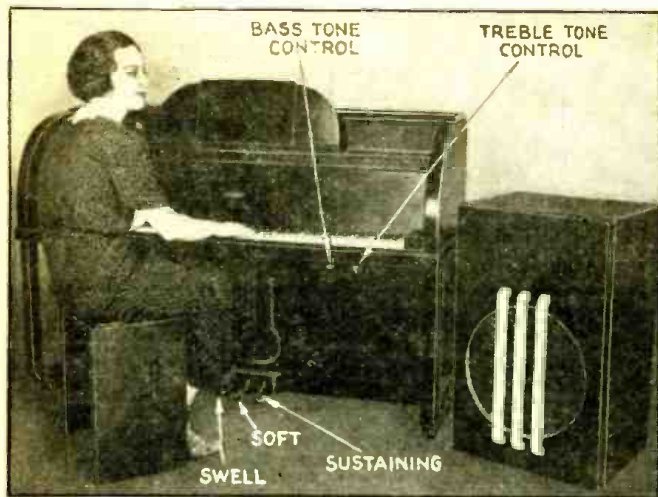

Fig. A. The electronic piano in use. The cabinet at right contains the loudspeaker and amplifier.

LATEST TONE-CONTROLLED ELECTRONIC PIANO

Service Men—post yourselves on the newest in "electronic" pianos. Musicians—learn how an electrostatic pick-up, amplifier and loudspeaker improved the piano.

H. K. BRETSFELDER

WHILE MANY electronic musical instruments have been produced, most of them have serious faults when compared to their corresponding acoustic instrument. One of the most pronounced faults of these instruments is their absolute perfection!

WHERE "PERFECTION" IS AN IMPERFECTION!

Were an artist to paint a picture of a field of wheat, even though he delineate every stalk perfectly, this picture would be much less interesting and less artistic than another picture of the same field, in which the artist, with a few bold strokes captured the feeling of the ripple of wind. In like manner, utter perfection in music is monotonous, while slight imperfections add life and sparkle to the music being produced. It was this, more than anything else, that led to the adoption of existing vibration producers—piano strings—with interesting imperfections over the theoretically more perfect synthetic oscillators. The "Electone" electronic piano, shown in Fig. A, uses that unique principle.

While the theory of this instrument is simple, a vast amount of preliminary new data on the science of music had to be accumulated and an equal amount of experimentation had to be gone through before the instrument reached its perfect form. Why electromagnetic, piezoelectric, magnetostriction and other methods of translation were discarded in favor of the *electrostatic* is no part of this story.

BASIC PRINCIPLE OF THE ELECTRON

Basically, the instrument consists of a vibrating string at ground potential, excited by a standard piano key, action and hammer. This vibrates in proximity to a charged screw, acting as a voltage pick-up (see Fig. 2). The electrostatic-voltage pick-ups of all strings are connected in parallel, and through the coupling circuits, to a vacuum-tube amplifier and a loudspeaker. The fundamental circuit and arrangement is shown in Fig. 1A. Basically, this is all there is to the "Electone."

The instrument is just as touch-

responsive as the acoustic piano and the accomplished pianist can strike 10 notes *simultaneously*, bringing out any one louder than the others, just as he is capable of doing on any piano. There is no limit, though, to the total volume of sound produced, if a suitable amplifier and speaker system is used.

As regularly furnished for the home, the instrument is equipped with a 30-W. high-gain, high-quality amplifier and a high-quality 30-W. speaker system. Tone controls for bass or treble suppression (see Fig. B) will give variations in the quality to suit the player; and attachments in the form of microphone for voice, or other pick-up, and use of the amplifiers with phonograph pick-ups, radio tuners and electric instruments such as guitars, may be provided. It is also possible to divert the output from the loudspeaker to a pair of high-quality headphones, giving a *practice instrument* with all the tonal gradations, BUT NONE OF THE EXTERNAL NOISE!

(Continued on page 421)

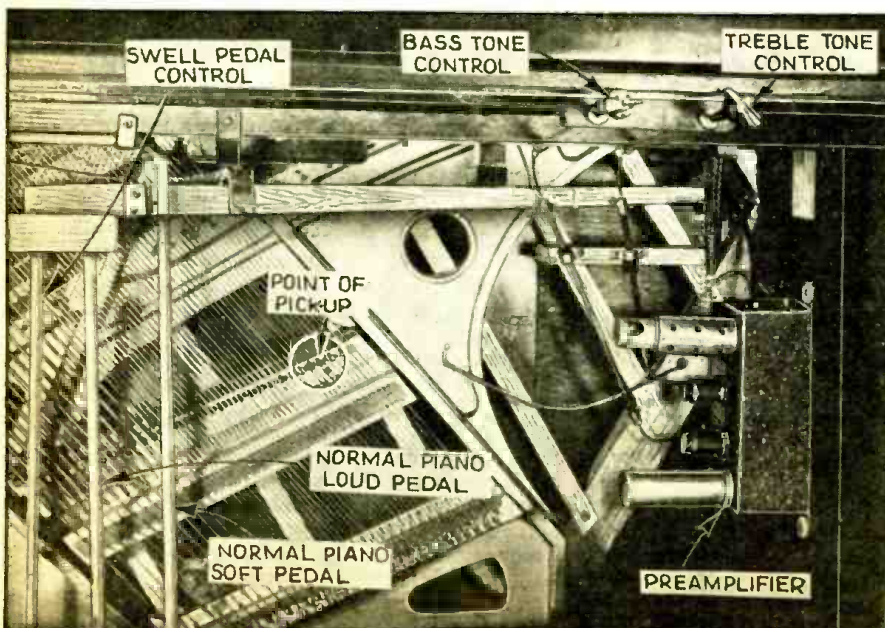

Fig. B. View looking inside the electronic piano. Showing, the normal piano "soft" pedal; normal piano "loud" pedal; the electronic "swell" (volume-control) pedal; bass tone control; treble tone control; the high-gain preamplifier; and, point along strings where pick-up is obtained.

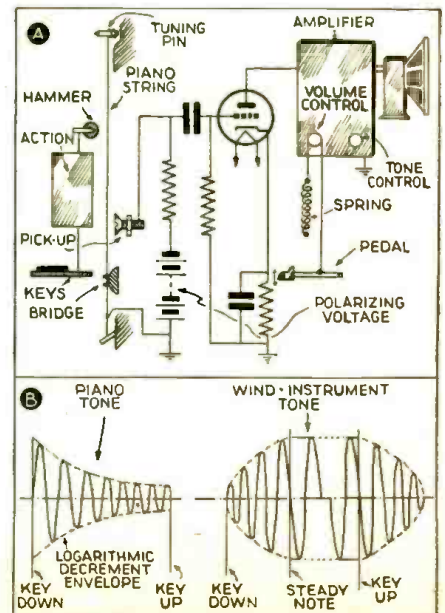
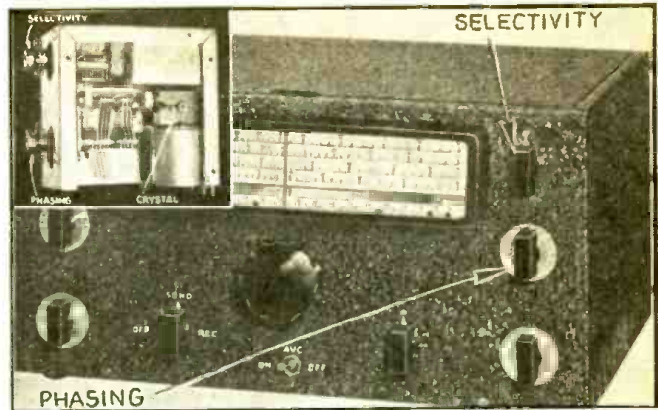

Fig. 1. A, the fundamental circuit of the electronic piano. All pick-ups are wired in parallel. B, Relationship between the tone of woodwinds and the electronic piano.

"HAM" SET USES NEW TUNED-CRYSTAL FILTER CIRCUIT

The crystal filter has been developed to such an extent that it now is extremely selective at an I.F. of 1,560 kc.



Location of controls; and view of filter (insert).

IMPROVEMENTS of importance in crystal filter design have made it possible to obtain, in the type NC-80-X short-wave receiver (frequency range, 30 megacycles to 540 kc.), continuously variable selectivity over the range of 300 cycles to 7 kilocycles. The locations of the crystal-circuit controls are shown in the photo; check these against the diagram.

The selectivity and phasing controls interlock, somewhat, in their action but the general principles of these 2 controls may be segregated without much difficulty.

The selectivity (bandwidth) control serves to establish the bandwidth range over which the crystal is to be effective. The phasing (rejection) control then is used to eliminate heterodynes or squeals between station carriers.

In order to obtain sufficient separation of image frequencies an I.F. of 1,560 kc. was selected; with this I.F. considerable R.F. discrimination can be obtained, without a preselector, at the high-frequency end of the tuning range of this receiver. At this high I.F., though, crystal-to-holder capacity becomes a problem. However, by making the discs of the crystal holder considerably smaller than the crystal, the shunt capacity was reduced to 6 mmf.; this helped

(Continued on page 441)

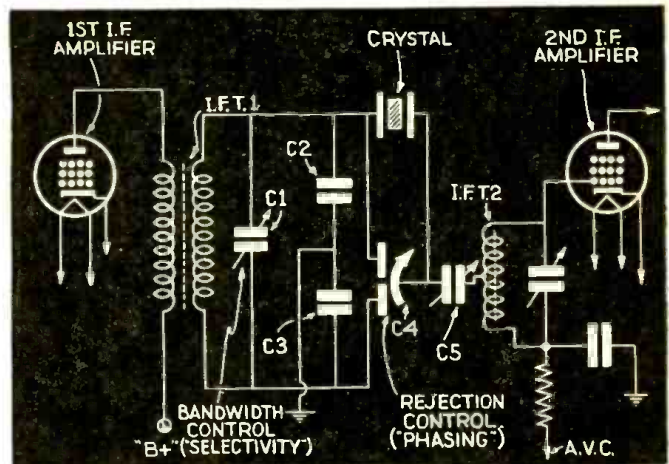

Circuit of the wide-range tunable crystal filter.

TELEVISION STUDENTS LEARN BY MAKING CATHODE-RAY TUBES

This description of steps in making a practical television receiving tube experimentally in a school laboratory is believed to be the first newsstand-magazine disclosure.

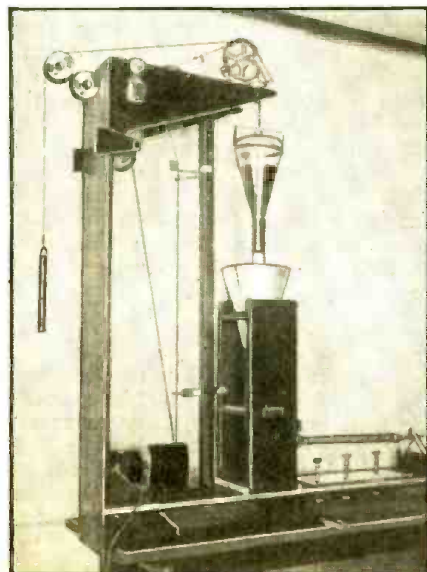

Fig. F. The complicated-looking (but simple) laboratory set-up for applying the internal graphite coating to the cathode-ray tube blank.

U. A. SANABRIA PART III

LAST MONTH WE DESCRIBED the mechanics of fusing the fluorescent screen to the glass of the cathode-ray tube. Now let's continue with the story.

After the screen is properly coated upon the inner-glass surface, the next step is to provide a thin graphite coating over the conical inner-surface.

THE GRAPHITE FUNNEL

The purpose of this graphite coating is to act as a focusing electrode in the cathode-ray tube and as a means of discharging the accumulated electrons on the surface of the screen. The electron beam would otherwise store, after a few seconds, so large an accumulation of electrons on the screen surface, that the beam thereafter would be repelled from striking the screen at all. The graphite coating is normally deposited

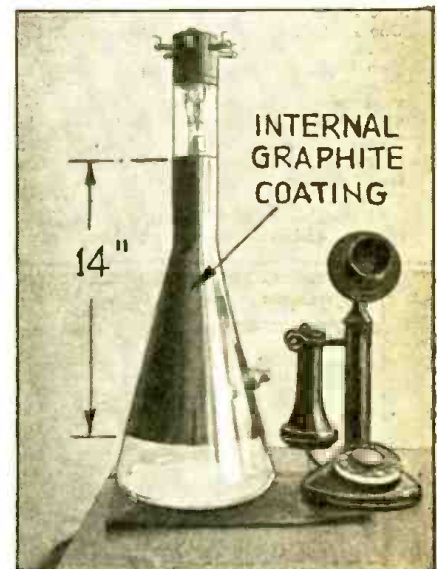

Fig. E. The telephone affords an excellent idea of the size of the completed C.R. tube. Note the extent and position of the internal graphite coating.

in the position shown in Fig. E.

It almost touches the screen, but is not actually connected to it. It also runs down the entire sloping surface and partway down the neck. It must be smooth and have a sharp, even edge. The graphite coating must be thick enough to provide a uniform electrical conductor or metallic funnel distributed throughout the entire inner surface with the exception of the screen front

(Continued on page 439)

HOW TO MAKE THE RADIO-CRAFT SUPER-DELUXE 30-TUBE SET

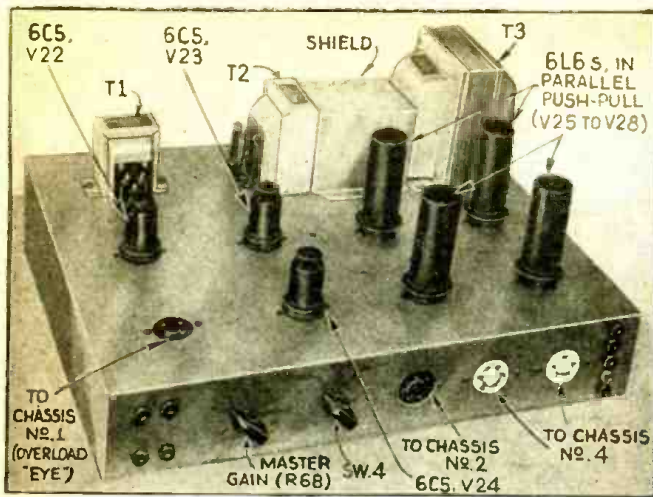

Fig. 1. Appearance of Chassis No. 3, the Audio Channel of the 30-Tube Set.

LIST OF PARTS

Four General Electric type 6L6 metal tubes, V25, V26, V27, V28;
 Three General Electric type 6C5 metal tubes, V22, V23, V24;
 One Standard Transformer Corp. input transformer, No. 4415, T1;
 One Standard Transformer Corp. interstage trans., No. 4701, T2;
 One Standard Transformer Corp. output trans., No. 3802, T3;
 Seven octal wafer sockets, 8 pins;
 Two 5-prong wafer sockets;
 *One steatite 5-prong ceramic socket;
 *One steatite 6-prong ceramic socket;
 *Three 5-prong male plugs;
 *One 6-prong male plug;
 One Centralab potentiometer, No. 72-105, 0.5-meg., R68;
 *One selector switch, No. 1313L, Sw.4;
 *Eleven terminal connectors, No. A016;
 *Two bar knobs, No. 366;
 *One chassis, No. 1524, 17 x 13 x 3 ins.;
 *Five tip-jacks, red, No. 520; blue, No. 529; green, No. 522; light green, No. 528; black, No. 521;
 *Two pairs of tip-jacks, red and black, No. 407;
 Two I.R.C. resistors, 1 W., 0.25-meg., R56, R57;
 Two I.R.C. resistors, 1 W., 25,000 ohms, R58, R59;
 One I.R.C. resistor, 1 W., 10,000 ohms, R60;
 One I.R.C. resistor, 1 W., 0.1-meg., R61;
 Three I.R.C. resistors, 1 W., 50,000 ohms, R67, R69, R70;
 Two I.R.C. resistors, 1 W., 5,000 ohms, R71, R72;
 One I.R.C. wire-wound resistor, 5 W., 2,500 ohms, R62;
 Four I.R.C. resistors, 1 W., 100 ohms, R63, R64, R65, R66;
 Three Cornell-Dubilier condensers, 400 V., 0.5-mf., C54, C56, C57;
 Three Cornell-Dubilier condensers, 400 V., 0.1-mf., C59, C60, C61;
 One Cornell-Dubilier condenser, 400 V., 0.05-mf., C58;
 One Cornell-Dubilier electrolytic condenser, 450 V., C55;
 Eighteen 1/4-in. rubber grommets.
 *Names of manufacturers will be supplied upon receipt of a stamped and self-addressed envelope.

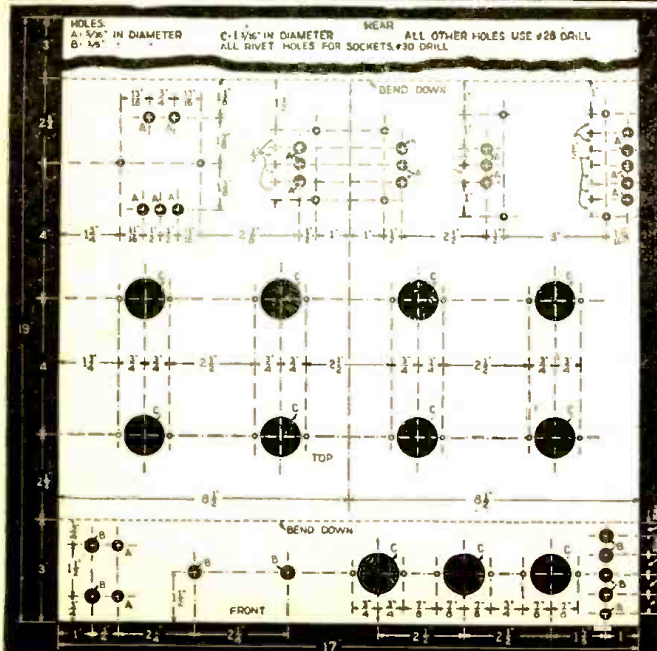

Fig. 14. Physical specifications for laying out and drilling the chassis.

THE THIRD CHASSIS of the *Radio-Craft* 30-Tube Set is perhaps the simplest of the 4, both to assemble and wire. Like the remaining chassis it may be used independently. In addition to other design features it is interesting to note that this 60-Watt Audio Channel includes fixed-bias for all the audio tubes (including of course the beam tubes); and inverse feedback to reduce distortion to an absolute minimum. The benefits afforded by *inverse feedback* have been discussed in past issues of *Radio-Craft*.

The tube complement, as shown in the photos and in diagram Fig. 13, consists of a transformer-coupled 6C5 working into push-pull 6C5s, which in turn are transformer-coupled to the 4 parallel push-pull 6L6s. The output of the 4 6L6s feeds into a large output transformer, which is especially designed to carry 60 watts of audio power. The secondary windings on this transformer are tapped so that a large number of speaker combinations are conveniently available, through the tip-jacks at the right edge of the chassis. A 500-ohm winding is also included for coupling remote speakers or for recording purposes. A 3-position switch allows the operator to switch from radio to phonograph or headphones as desired. Tip-jacks are provided on the chassis for high-impedance phonograph pickups and headphones. A master gain control is also included on this chassis for the purpose of reducing the input signal of whatever source is used.

The 3 sockets on the back apron of the chassis are used to connect together the *power supply* and the *automatic bass circuit*.

THE AUTOMATIC BASS CIRCUIT

A study of the schematic, Fig. 13, will disclose the fact that a certain part of the signal voltage developed across the primary of the input transformer T1 is applied to the diode plates of the 6R7 in the automatic bass circuit, located on Chassis No. 2.

The larger this voltage, the larger will be the bias applied to the control-grid of the 6K7 bass amplifier tube, thus reducing the gain of the low-frequency branch of the circuit. Conversely, when the volume control is turned down to a low level, the bias applied to the 6K7 is very small and the gain of the low-frequency branch is very high, thus boosting the low notes (up to approximately 800 cycles) considerably. The 6K7 bass tube circuit resonates at approximately 40 cycles, while the high-frequency branch, comprising the 6C5 and 6R7 cuts off at 500 cycles and extends upwards to 10,000 cycles. By means of the high- and low-frequency controls on Chassis No. 2, many interesting mixtures of high and low frequencies are made possible.

HIGH GAIN

The overall gain of the audio channel is very high, and for this reason *every* plate and grid lead *must* be shielded and grounded to chassis. It may be necessary to rotate slightly the input transformer T1 if the hum level is high enough to be audible. The master gain control should be kept turned down about halfway for ordinary reception. The 6E5 overload indicator is connected so that the shadow is narrowed to a fine line. This line broadens only when the push-pull 6C5s are being driven positive. The input signal should never be allowed to reach this point because severe distortion and possible damage to the 6L6s will result.

This Audio Channel, the same as the other chassis of the *Radio-Craft* Super-Deluxe 30-Tube Set, may be used independently; 60 W. output is available, and positive tone control is obtained with an Automatic Bass Circuit as a particularly useful feature.

**CHASSIS No. 3—
AUDIO CHANNEL**

PART IV

The layout of the chassis is shown in Figs. I and J, and as can be seen, it is very simple to build and wire. The drilling layout for the chassis is given in Fig. 14. If any substitution of parts specified in the List of Parts is made, exceptional care should be taken that the parts used are at least equivalent, electrically if not mechanically, to those used and specified in this article.

The control panel on the front skirt of the chassis is not shown in Fig. 15. Instead, it is shown in detail in Fig. 16. In Fig. 16 the selector switch is marked R, P, E, to designate, respectively, *radio*, *phones*, and *external*. The audio output to loudspeaker is taken from tip-jacks at extreme right; those at upper-left feed headphones only. The tip-jacks at lower-left connect to magnetic or crystal pickup, carbon or velotron mike, etc. Ceramic sockets (A) and (B) connect to Chassis No. 4.

This Audio Channel may be used independently if powered by a heavy-duty power supply. The Automatic Bass feature, however, due to space limitations has been included in Chassis No. 2 (the I.F. Channel) and hence is not available for independent use. Note that, as will be seen next month (table—Operating Voltages), operating all the tube filaments at 6.1 volts increases tube life and lowers operating cost.

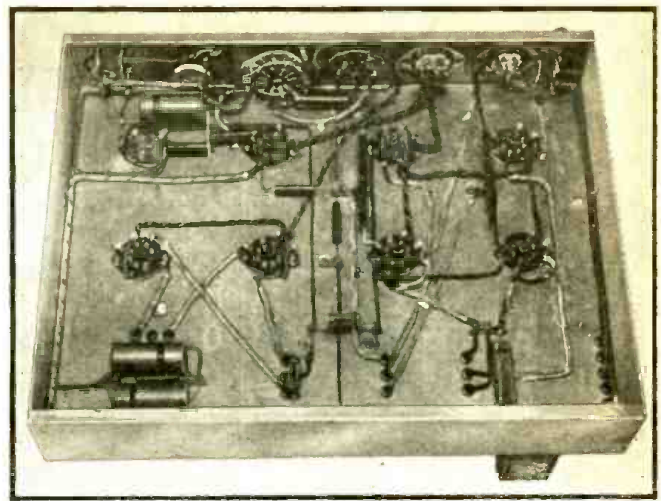

Fig. J. Under-chassis view of Chassis No. 3 showing the orderly wiring.

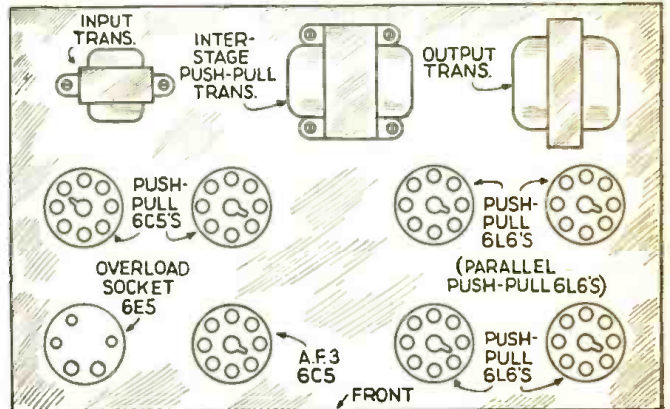

Fig. 15. Proper spacing and placement of components helps considerably to reduce hum.

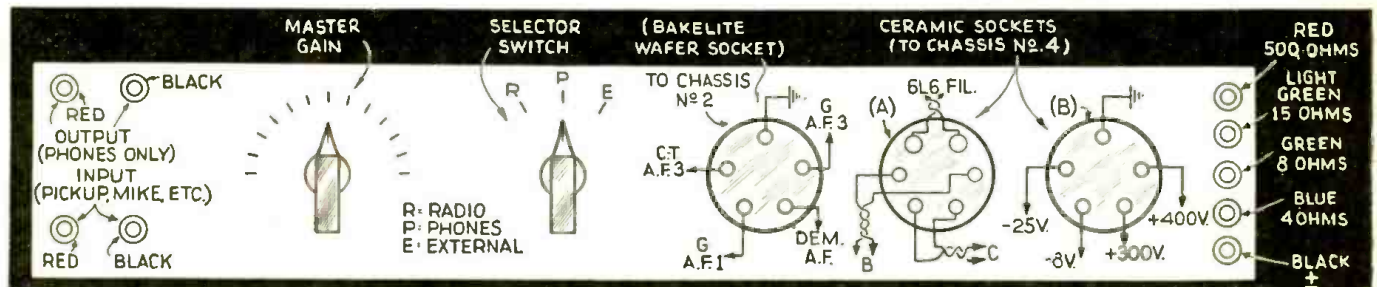

Fig. 16. Use this chassis independently as a Public Address amplifier; or inter-connect it to chassis Nos. 1, 2 and 4 by means of plug-in cables (see Fig. 13).

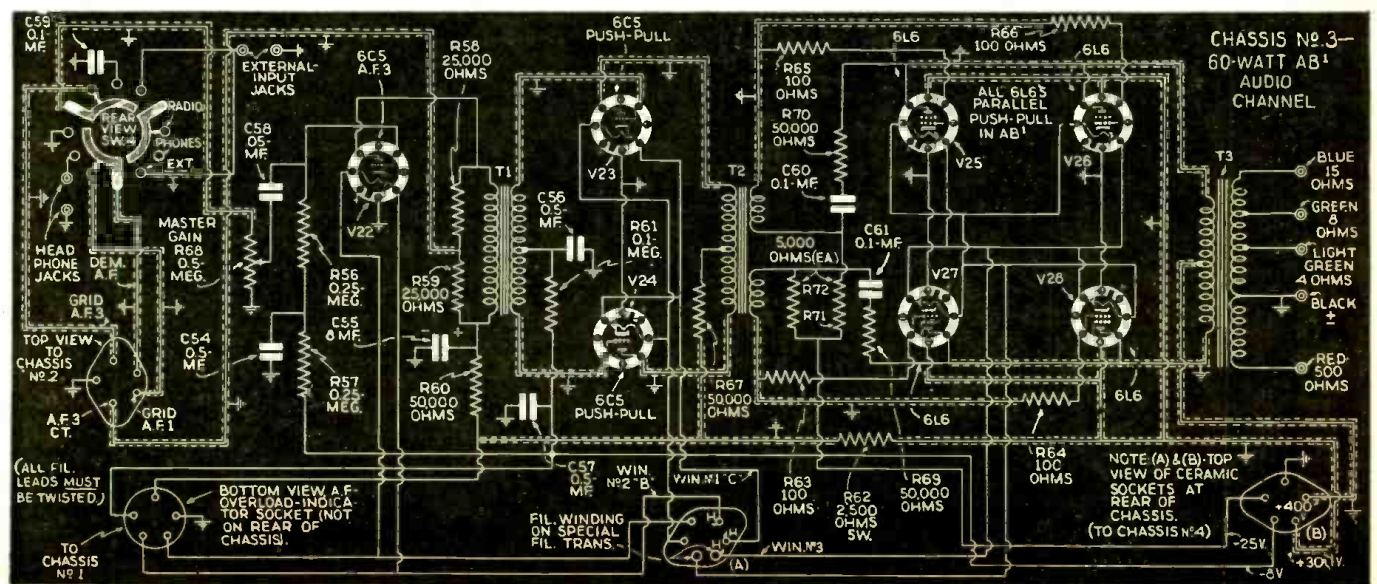

Fig. 13. Schematic diagram of the Audio Channel of the *Radio-Craft* 30-Tube Receiver. It is important to shield all wires so indicated above.

NEW CIRCUITS IN MODERN RADIO RECEIVERS

The details of the modern radio receiver circuits that make them "different" from previous designs are illustrated and described each month by a well-known technician.

F. L. SPRAYBERRY No. 4

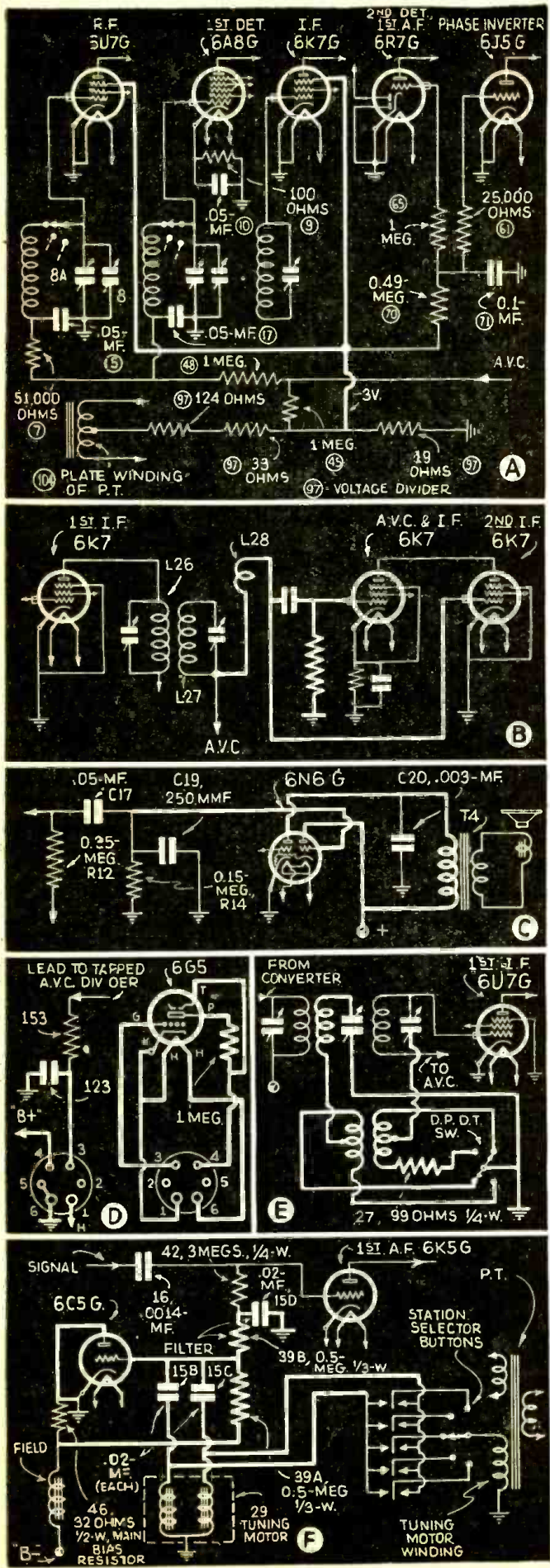

Fig. 1. The heavy lines in the circuits are the points discussed in the text.

(1) SUPPRESSOR BIAS FOR HIGH-FREQUENCY STAGES

Philco Model 38-1. The circuit of Fig. 1A is taking advantage of the increased A.C. plate resistance afforded by biasing the suppressor-grid by an amount equal to that of the control-grid. Minimum fixed biases for the R.F., 1st-detector, I.F., 1st A.F. and phase inverter, and the R.F. and I.F. suppressors, are supplied from a common source which is the drop across a resistor in the negative high-voltage D.C. lead. The R.F. and 1st-detector control-grids are further subject to the usual A.V.C. changes.

(2) IMPROVED CIRCUIT CHARACTERISTICS WITH I.F. COUPLING COIL

R.C.A. Model 816 K. This set uses a separate coupling coil to feed the grid of the 2nd and A.V.C.—I.F. stages. As illustrated in Fig. 1B, the load on the tuned secondary would be excessive with connection of 2 grids so this coupled winding at a lower impedance may easily feed both grids adequately and yet not materially reduce the "Q" of the tuned winding.

(3) SIMPLIFIED 2-STAGE OUTPUT

Silvertone Model 4600. This automotive receiver acquires output action using no transformer or external loads. A 6N6G tube is made to perform 2-stage action by connecting the 1st-stage cathode and the 2nd-stage grid as in Fig. 2C.

The output load of the 1st stage is in its cathode lead instead of its plate lead, and consists of the grid cathode circuit of the 2nd stage. Cathode voltage variations, due to the signal, are conducted to the 2nd-stage grid. This results in high gain in a greatly simplified circuit.

(4) PLUG-IN TUNING INDICATOR

Stromberg-Carlson Model 229-P. The new Stromberg-Carlson line arranges the entire tuning unit with electron-ray tube as a plug-in assembly. A cable attaches it by a 6-pin plug and socket so that it may be plugged-in for operation. It may be used locally or remote to the receiver. Although a 6-pin plug and socket are used only 4 connections are needed as in Fig. 1D.

(5) VERSATILE LINK I.F. COUPLING

Crosley Model 1127. This receiver accomplishes extreme flat-top or "sharp" selectivity in a single stage. By an auxiliary coupled winding group as in Fig. 1E, and a double-pole—double-throw switch, a resistor may be placed in series with the I.F. secondary while the sides of the resonance curve remain steep through loose coupling.

(6) ELECTRONIC "MUTER" FOR MOTOR-DRIVEN DIAL

Crosley Model 1137. This receiver uses no mechanical switch for shorting the audio signal circuits to make the receiver quiet while the motor turns the dial. As indicated in Fig. 1F, a tube serves this purpose. Connected as a diode with plate and cathode grounded, and control-grid to a junction of 2 resistors in the 1st-audio bias, grid impulses make this point negative enough to completely block out any signal. Both the motor field supply voltages and control switch transients produce immediate audio blocking through condensers 15B and 15C.

SERVICING QUESTIONS & ANSWERS

Service Men may write, requesting answers to specific service questions. Address inquiries to Service Editor. For questions answered by mail, a service fee of 25c per question is made. Only questions of wide interest can be published. In view of the "rush" character of most service calls an effort is made to maintain 48-hour service on mail inquiries. Let us help you solve your service problems.

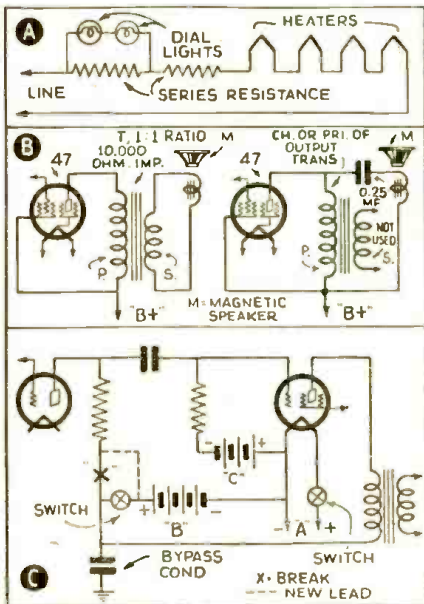

Fig. Q.36 (A)—pilot burnouts; Q.37 (B)—connecting magnetic speaker; Q.38 (C)—"blocking" repair.

DIAL LIGHT BURN-OUT

(36) D. A. Piegorsch, Bartlett, Ill.
(Q.) I have a Knight 5-tube midget receiver which was purchased from a radio mailorder house in Chicago.

Within the last 2 weeks, the dial lights have been burning out. How can this be corrected? There are two 6.3-V. pilot bulbs in this set wired in series.

(A.) You do not state the model number or type of receiver in question. However, the fact that two 6.3 V. pilot bulbs are employed in series points to an A.C.-D.C. model.

In this type of receiver, the heaters of all tubes are wired in series and connected to the line or source of voltage through a series resistance. A tap on this series resistance is employed usually to supply the voltage for the pilot bulbs, which are connected across this portion of the series resistance as shown in Fig. Q.36 A. The series resistance may be in the form of a ballast tube or a resistance in the line cord.

Your difficulty is due undoubtedly to an intermittent open-circuiting of that portion of the series resistance across which the pilot bulbs are connected. When this occurs, the heater current for all the tubes in the receiver momentarily passes through the pilot bulbs, thus ending their useful life. Since the tubes are of the slow-heater type, an instantaneous open-circuiting of the series resistance is unnoticeable. Ballast tubes used as series resistances in A.C.-D.C. midgets are notorious for this defect. Replace the ballast.

MAGNETIC SPEAKER CONNECTION

(37) Sam Koide, Honolulu, Hawaii.

(Q.) I would like to connect a 5-in. Vitavox magnetic speaker to a type 47 tube of a receiver. I would like to know whether it is necessary to match the impedance of the tube and speaker?

(A.) To properly match the plate impedance of the type 47 tube, a load resistance of 7,000 ohms is required for maximum undistorted output. The impedance of the magnetic speaker mentioned in your inquiry will meet the requirement of impedance matching satisfactorily. However, since the 47 tube under normal operating conditions draws more than 30 milliamperes, some method should be employed to protect the speaker windings. Although the speaker may be connected directly into the plate circuit of the 47, it is more usual and advisable to couple the speaker to the tube through some output coupling device. This may be an output transformer with a 1:1 ratio and of 7000 to 10,000 ohms impedance, or through an output choke (which may be the primary of an output transformer of suitable impedance with secondary disconnected from any circuit), and condenser, as shown in Fig. Q.37 B.

CONNECTION BLOCKING

(38) R. L. Jacobsen, Jeffers, Minn.

(Q.) I have had occasion to work on 2 Philco radio sets lately that had the same symptoms. (Continued on page 441)

ANALYSES of RADIO RECEIVER SYMPTOMS OPERATING NOTES

Service Men: Illustrate, wherever convenient, your Operating Notes on characteristic faults of given sets. Payment is made after publication.

Philco Model 70. Intermittent Cut-out. Replace 0.01-mf. audio coupling condenser. The 47 tube may also have to be replaced. To test this, use a piece of insulated wire with bare ends and with receiver tuned to a station, bridge across the condenser and quickly take both ends of wire away. Do this several times and if there is a great reduction in volume, tube will have to be replaced. Philco Model 90 (with single 47) has also the same fault.

Philco Model 70. Local station (720 kc.) received with low volume at approximately 680 kc. No other stations. This can be "intermittent" and is caused by a faulty condenser across the low-frequency padder.

Intermittent reception—Faulty oscillator condenser.

Philco Model 60. To increase power, replace cathode resistor (200 ohms) in cathode circuit of 78 and 6A7 with 100-ohm value (old model) and cathode resistor in cathode of 78 (400 ohms) with 200-ohm value (new model).

Philco Model 89. All stations at low-frequency end of dial disappear, sometimes from 550 kc. to 1,400 kc., may be "intermittent." Replace 36-type tube with type 77. Also change tube socket, 15,000-ohm cathode resistor to 8,000 ohms, and add a 0.001-mf. condenser-to-cathode condenser. Cathode and suppressor-grid joined together.

Philco Model 112. Distortion on local station—faulty A.V.C. resistor to first R.F. tube. Replace with 70,000 ohms value.

MELHUSH & COMPANY,
South New Brighton, New Zealand

Atwater Kent 40. This receiver lacked volume and was very distorted. I found that the distortion and lack of volume originated in the 71A output stage.

To repair this condition, all that is required is a 50,000 ohm resistor and a 0.25-mf. condenser. I placed the 50,000-ohm resistor across the speaker binding posts and the 0.25-mf. condenser in series with the magnetic speaker. There is now an evident increase in volume and tone quality.

JEROME BERGER

Lyric 470-B. A Lyric 470-B came in for repairs which had been tampered with by 3 other Service Men (gyps). The trouble—no short-wave reception. Long-wave, very good.

The usual service bench testing failed to reveal any trouble. Voltages, tubes, condensers, etc., all showed perfect condition. After 2 hrs. of continuous testing, the trouble was finally located in the 50-mmf. condenser. This condenser is usually on band switch.

All American Mohawk Lyric SW88. This trouble may sound like a fairy tale or sound like I've gone nuts, nevertheless, it's a fact which took 9 days to remedy.

This set was 18 months in use, traded in and resold. The second purchaser had splendid results for 5 months, when the set commenced stopping after 1½ hours of use. After three-quarters of an hour testing, no trouble was located. Next morning the set was turned on and, to my surprise, short-wave reception was exceptionally good. But, behold, exactly 1½ hours of operating, dead she goes! Still nothing showed up. This went on for 9 days. Still I couldn't locate the trouble. Leaving the set overnight, she would operate next morning as usual for 1½ hours.

Suspicious condensers and resistors were replaced, but to no advantage. My final smack at this set was to rip the 10,000-ohm resistor from the oscillator and replace it with new one. On the oscillator coil there are only 2 resistors—0.5-meg. and 10,000 ohms—going to ground. Only the 10,000-ohm unit is bypassed by 0.05-mf. condenser. Immediately the 10,000-ohm unit was replaced, the set performed as she should. How this resistor reduced itself down to a few ohms still is a mystery to me. It contained no voltages and was acting only as a bias resistor. Nevertheless, I didn't trouble to find out. But in the future I'm going to look for defects *not* under suspicion, *not* vice versa.

By the way, replacing the 47 in this particular model with a 2A5 increases the tone 50% and does away with the mushy tone which was so noticeable before the change.

F. NOSWORTHY,
St. John's, Newfoundland

Philco 45, 345. This was one of the last Philcos to use a drum dial. It was rather slow, but very smooth in action. On some sets of this model I have found a scratchy, raspy form of intermittent interference only on the short-wave band and generally just around 12 megacycles. I spent a lot of time on the first one; but now I stop it in a few shakes by lubricating this dial drive mechanism with fine oil. In the remote possibility that this does not clean up the trouble, it may be necessary to use bakelite pulleys; but so far this has not been necessary.

DeForest-Crosley "Ballad," Sonora D-50. Break-down in almost any set having a screen-grid detector resistance-capacity coupled to a pentode (Continued on page 434)

HOW TO MAKE A 2-WAY "HAM" STATION FOR 5-METER PHONE

The receiver of this 2-way ultra-high frequency station tunes from 5.5 to 2.5 meters. Transmitter, using crystal to prevent frequency modulation and drift, has new 6C8G.

J. B. CARTER

IT IS IMPORTANT that the experimenter about to delve into the intricacies of high-frequency transmission should realize that frequencies of 56 megacycles (about 5 meters) and above behave more like light waves, whereas longer radio waves are reflected back to earth by the Heaviside Layer.

FACTORS AFFECTING ULTRA-SHORTWAVE DX

Until recently, only the "ground wave" was considered of any value for these high frequencies; however, occasionally these radio waves are reflected back to earth by the Heaviside Layer with the result that they are received over great distances. This effect, of course, depends upon the degree of ionization in the Heaviside Layer, the height of which varies with the season of the year, time of day and (observations seem to indicate) sunspot activity.

Observations taken at the Blue Hill Observatory near Boston indicate that, when warm air is running over a stratum of relatively cold Polar air, communication distance is considerably increased. It was also observed further, that when this meteorological condition exists, considerable bending of the waves in the lower atmosphere occurs. As this atmospheric condition is almost always existent each night, the transmission range is considerably greater at night than during the day. In view of this, it can be safely assumed that transmission and reception are often

erratic due to atmospheric changes.

This inability to forecast the range of ultra-high-frequency reception is a phenomenon which appeals to many, since the resulting unexpected occurrences provide thrills over and above those experienced in connection with operation at the lower frequencies.

Relatively little power is required and for communication over a range of only a few miles, 1 or 2 W. of power will provide very satisfactory results. For a number of years the combination transmitter and receiver, called the *transceiver*, has proven very popular mainly due to its low cost. However, the transceiver has many disadvantages, especially as regards its service as a transmitter.

Crystal Solves Problems. The greatest difficulties encountered in ultra-high-frequency transmitters are *frequency drift* and *frequency modulation*. In order to overcome these difficulties it was decided to construct the crystal-controlled transmitter illustrated in Fig. A, B and C. The crystal utilized is a so-called "14-megacycle" type. It might be well to point out that many of the 20-meter crystals are really 60-meter crystals but are exceptionally good oscillators on the odd-harmonics of the fundamental.

This ultra-H.F. transmitter and receiver is an extremely compact unit and, while ideal for mobile use, can also be used as a fixed station.

(Continued on page 436)

NOTICE TO BEGINNERS

If construction of this 2-way ultra-high frequency station marks your initiation into the field of amateur or "Ham" radio, do not attempt to operate the station until you've acquired a license to put this equipment "on the air," and another license to operate it. In brief, getting a license entails the following general procedure: (1) learn to receive and send the Continental telegraph code at the rate of 13 5-letter words per minute; (2) learn the U.S. Government regulations regarding radio transmission and reception; and, (3) study elementary short-wave radio theory until you are able to draw the diagram, and explain the operation, of the transmitter you plan to use. (*Radio-Craft* will be glad to supply a list of books, covering the requisites outlined above for passing U.S. radio license examinations, upon receipt of a stamped, return-addressed envelope.)

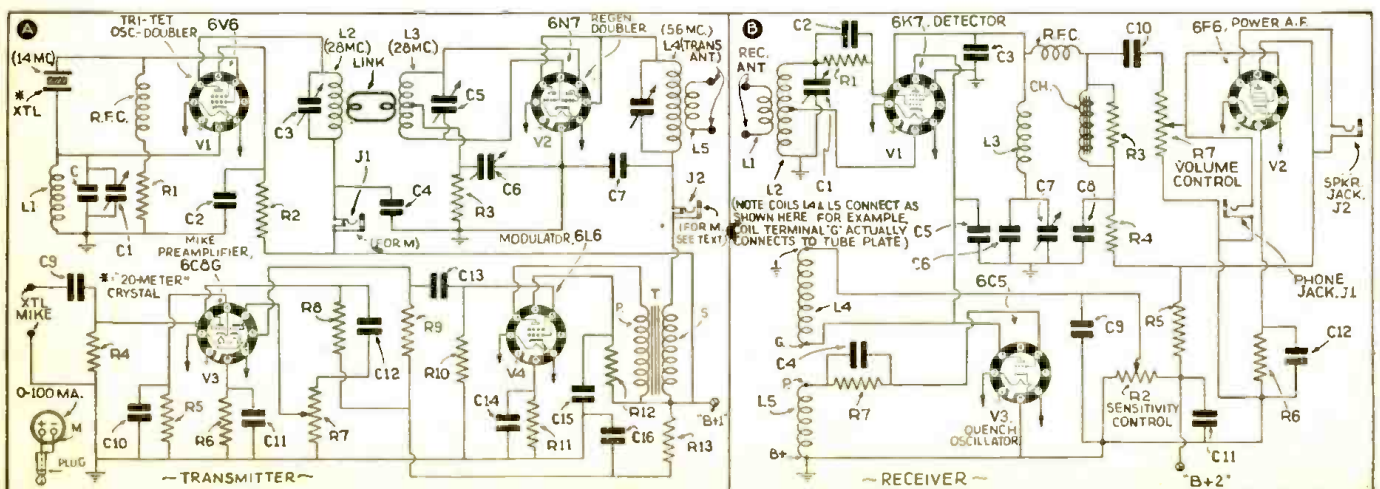

Fig. 1. Note the use in this circuit of the new 6C8G tube as a preamplifier in order to utilize crystal microphone. The new 6V6 is incorporated in the transmitter as a tri-tet oscillator-doubler. In the receiver, a 6C5 operates the quench tube in a novel circuit.

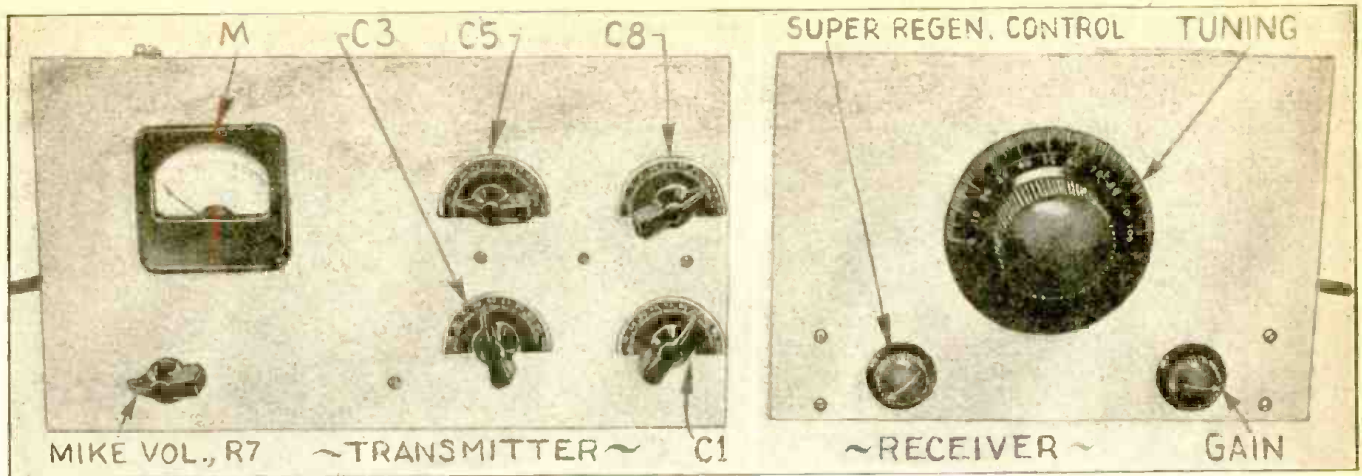

Fig. A. The new square meter gives this amateur transmitter a "commercial" appearance; as the limited number of panel controls indicate, the receiver is simplicity itself. You may build this radio station with the assurance that it will give a good account of itself.

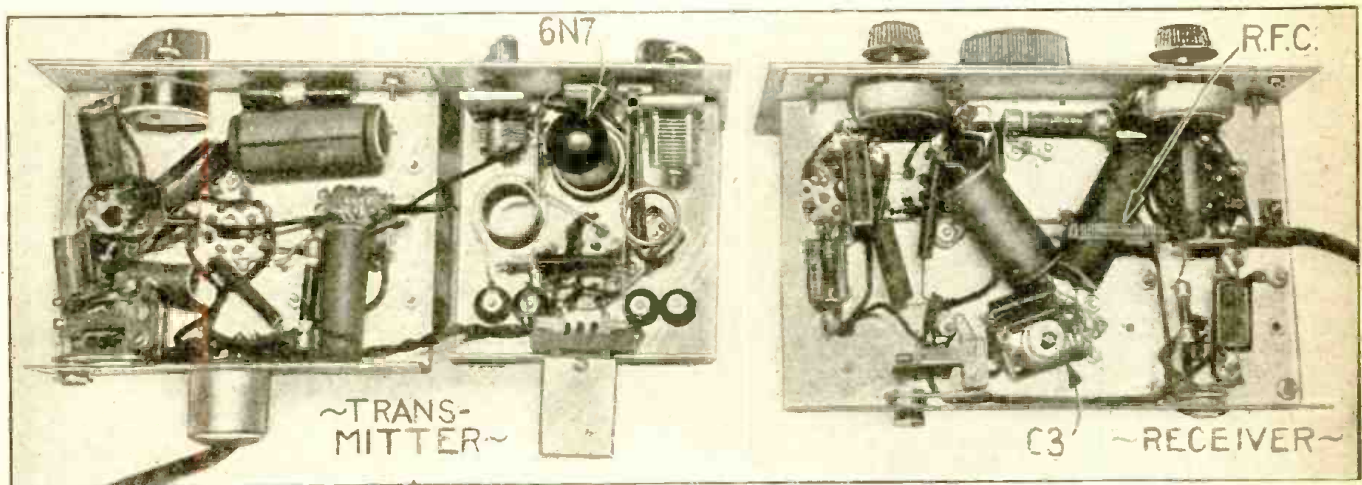

Fig. B. Note how the transmitter's tubes and associated tuning circuits are segregated. The receiver's quench coil is contained in a shield-can. All wiring is kept as short as physically possible.

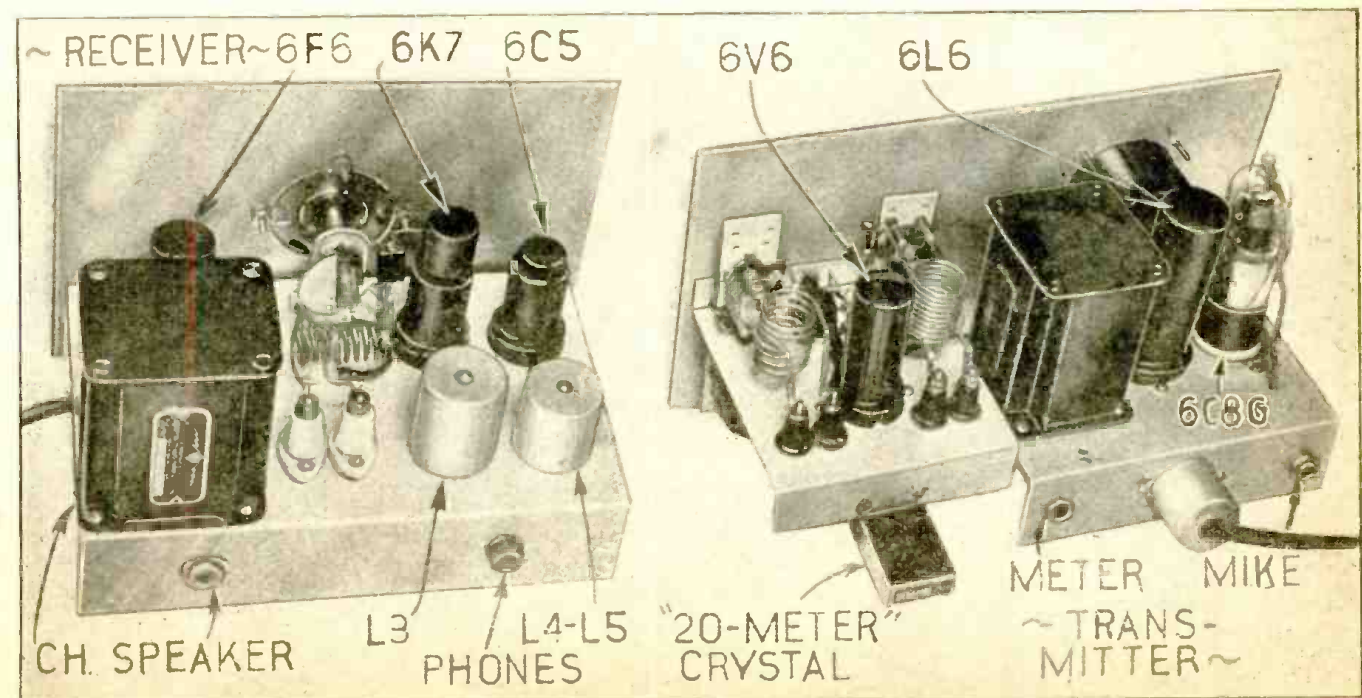

Fig. C. Observe, once again, how tubes and coils are placed for short leads. The crystal, isolated from the tubes, is easily kept cool. A vernier dial is used in tuning the receiver.

"LEARN-BY-EXPERIMENTING" BEGINNERS' PRACTICAL RADIO COURSE

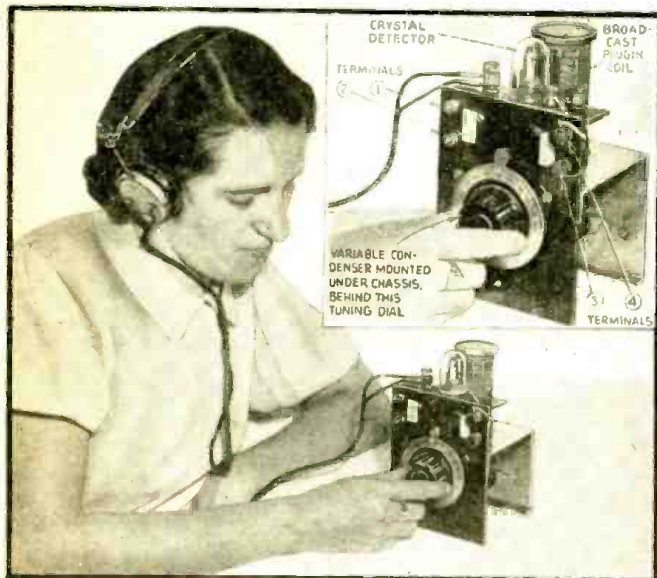

Fig. A. The wavemeter, with the addition of a crystal detector, will afford the experimenter the additional pleasure of a good Crystal Receiver.

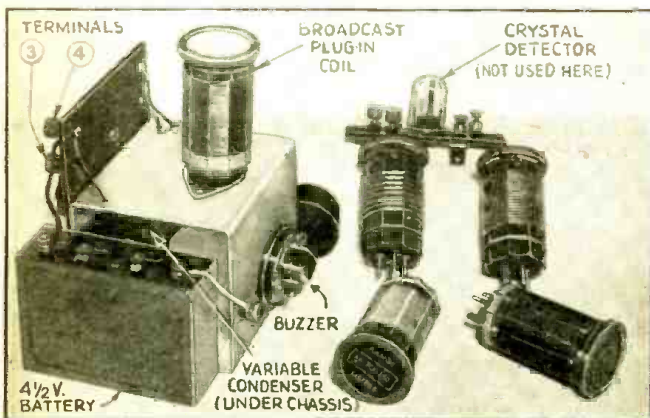

Fig. B. With the crystal detector removed the apparatus can be used as a simple Wavemeter or Signal Generator for aligning receivers.

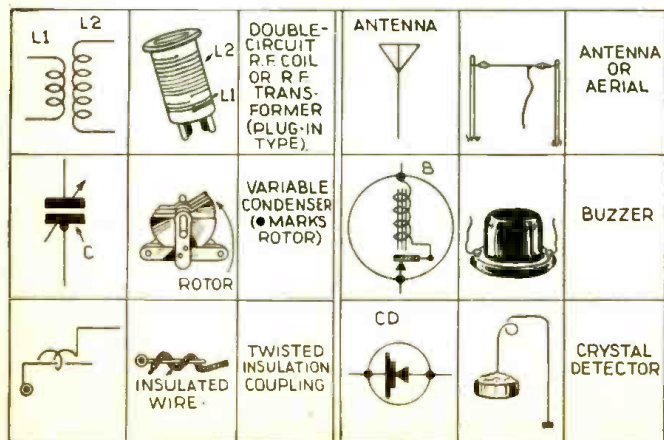

Fig. 1. Radio symbols of parts used in this Experiment.

EXPERIMENT No. 4

SIMPLE WAVEMETER AND SIGNAL GENERATOR (INCLUDING CRYSTAL SET CIRCUIT)

New way of learning radio!—You learn basic principles while building useful radio units. The lessons are directed by a man well fitted for the task . . . a radio instructor.

CONDUCTED BY

SOL D. PRENSKY

THIS EXPERIMENT, the 4th in the series, deals with the construction of a *tuning unit* which will be provided with a scale marked in kilocycles (kc.), for use as a *simple wavemeter*. The tuning unit consists of a coil (marked L2) and condenser (marked C1) combination (see Fig. 3A), which, by means of its *calibrated* scale, will enable one to determine to what wavelength or frequency any receiver (and also any transmitter) is tuned to. The tuning can be determined in terms of either the *wavelength* or of the *frequency* of the radio waves. For example, for tuning-in station WMBQ, the number given is 1,500 kilocycles, which is the frequency of its radio wave. The corresponding wavelength of this same station is 200 meters. Although frequency and wavelength are thus seen to be two aspects of the same tuning, the customary designation of a station is by its frequency, and the name *frequency meter* therefore is often used instead of *wavemeter* (both names are correct).

FUNCTION OF WAVEMETER

There are many uses for such a basic device as a wavemeter. It enables the user to definitely determine the frequency of any unknown station to which a receiver is tuned, and conversely, also enables him to set the dial of his receiver (a process called *aligning* or *calibrating*) to any frequency which he desires to tune-in. This latter use is particularly helpful in the case of operating experimental sets, such as are described in this issue, where it is necessary to locate the different frequencies on an unmarked dial. In such cases, by using a wavemeter, the desired frequencies may be marked on the dial or, preferably, the location of the frequencies may be shown on a *tuning curve*, such as is described in this Experiment.

When a wavemeter is being used in the above manner to *calibrate* a receiver, the tuning circuit of the wavemeter is usually energized by some means to produce its own waves. It then becomes a "Generator" of *radio waves*. The generator is also called a *radio-frequency oscillator*.

In this Experiment, our wavemeter is made to perform as an *R.F. (radio-frequency) oscillator*, in a very simple and effective manner, by using the familiar *buzzer* as the energizing agent. Since the frequency of the generated wave is known (because, as we shall see, our wavemeter is calibrated), we can set (or align) any receiver on its desired frequency by tuning the set under test to the known generated wave.

Various types of wavemeters, varying widely in cost, are commercially available, their cost depending mostly on the accuracy of calibration necessary for the particular use of

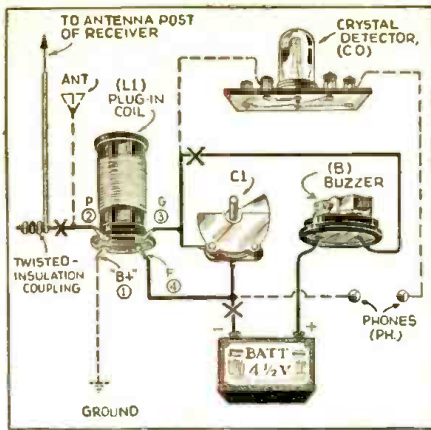

Fig. 4. Pictorial diagram of the Wavemeter. (See text for explanation.)

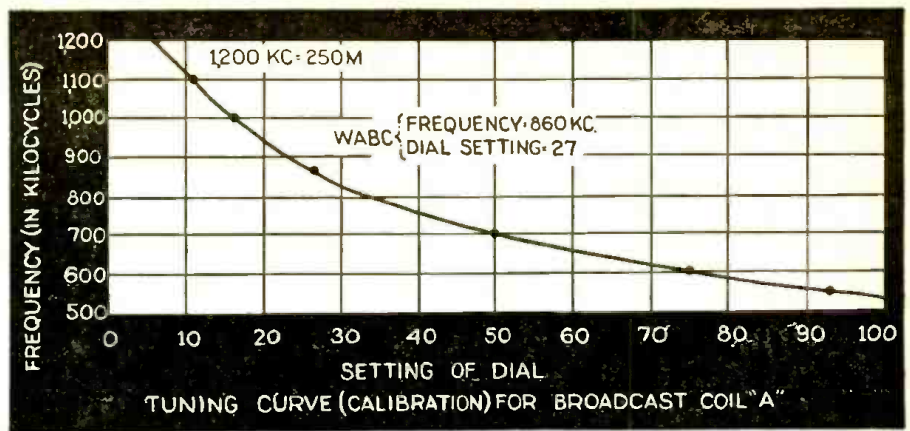

Fig. 2. This calibration chart permits interpretation of the Wavemeter dial readings into kc. or meters. A separate chart should be made for each plug-in coil.

the device. Thus for example in the service industry a wavemeter known as a *signal generator* or "service oscillator" is an essential part of the Service Man's equipment for adjusting or as it is called "aligning" the variable condensers to a particular frequency. The accuracy of the signal generator's calibration is the important characteristic of the various types, and the degree of accuracy required of any particular type will vary widely according to its use. This can readily be seen by comparing the requirements for a Service Man's signal generator with those of a laboratory standard (such as is used by the manufacturers of signal generators themselves), which sells for about \$400 with its guaranteed accuracy of 1% based on an ultimate astronomical standard. It is obviously unreasonable for the Service Man to expect equal accuracy, relative to such an ultimate standard, for his signal generator selling around the \$50 mark.

In interpreting the figure given for *percentage accuracy*, therefore, it all comes down to the question of the basis of comparison, and it is well to realize that, considering the non-laboratory conditions under which the ordinary signal generator is used, an over-all accuracy of 25%, with respect to a laboratory standard (which would be within 3% of an ultimate standard), is quite sufficient for service work. This figure will still represent a much higher order of accuracy than the radio set with which he is comparing his signal.

In the case of an experimental unit, such as a "roll-your-own" unit described here, where the method of frequency measurement is the main thing, and a first estimation of frequency is sufficient to show this principle, we can avoid many complications and much expense, by using the simple buzzer arrangement and preparing a *chart* accurate within even 5% of standard, and still retain the inherent usefulness of the device.

ADDITIONAL CIRCUIT FOR A CRYSTAL RECEIVER

The tuning unit of the wavemeter can also be made the basis of a simple radio receiver. To illustrate this it will be shown how a simple *crystal receiving set* can be made from the tuning unit by the addition of a crystal and a pair of headphones, as shown by the circuit diagram (Fig. 3B), and by the dotted lines in Fig. 4.

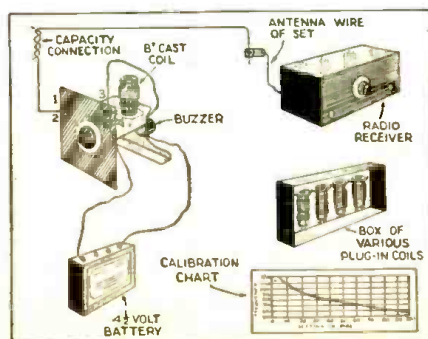

Fig. 5. Coupling the Wavemeter to a receiver.

THE EXPERIMENT—WAVEMETER AND WAVE GENERATOR

OBJECT: To study a Wavemeter Unit, for measuring the frequency (or wavelength) of a radio wave.

(Part A) Construction and calibration of the wavemeter.

(Part B) Using the wavemeter for determining the frequency to which a radio receiver is tuned.

Added Circuit (Part C) Converting the wavemeter into a crystal receiver.

PRINCIPLE OF OPERATION

The fundamental principle involved in a wavemeter is that of *resonance*, that is, of causing one unit to be *in tune* with another. This principle is obviously being employed every time a radio set is *tuned* to a broadcast station, which sends out radio waves as a result of exceedingly rapid electrical vibrations (usually above 25,000 cycles [times per second]). Thus the radio wave from station WMBQ, for example, is known to have a frequency of 1,500 kilocycles (which is 1,500,000 cycles).

In tuning-in this station on a receiver, we obtain resonance by the combination of the amount of *inductance* (L) of a coil and the amount of *capacity* (C) of its associated variable condenser. (The resulting value of this combination becomes the *LC product* [or ratio]; see Fig. 1 for symbols); this also may be expressed as "*L/C ratio*." As the variable condenser of the receiver is rotated, its capacity is altered until a point on the dial is reached where the L/C product of the combination (multiplied by a constant factor) exactly equals the frequency of the desired station. At this point on the tuning dial, we are in *resonance* with the broadcast station, and the dial could therefore be marked at this point with the frequency of the transmitting station. Any movement of the tuning dial, either to the left or to the right, will cause our combination to be in-tune to some other frequency than the one desired. Such an *off-tune* condition results in poor reception, and many sets make some additional provision to visually indicate resonance, other than the factory-marked dial. The *tuning eye*, which is now so justly popular, is an example of such a resonance indicator.

(Continued on page 424)

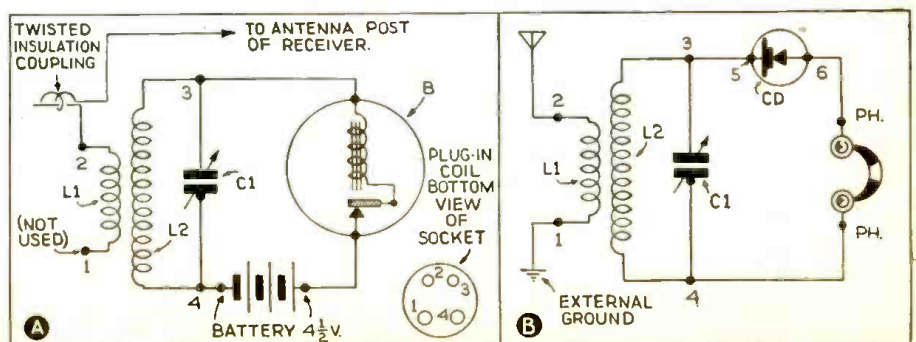

Fig. 3. Schematic diagram of (A) the Wavemeter; and, (B) its modification as a Crystal Set.

HOW DEPENDABLE ARE YOUR METER READINGS?

The author, whose published works include such well-known texts as "Radio Physics Course," "Modern Radio Servicing," etc., concludes in this chapter his series of articles for Service Men analyzing meter "accuracy."

ALFRED A. GHIRARDI.....PART IV

THE PRECEDING Parts of this article, and the following material, together present to you a more comprehensive survey of the subject of both *inherent* and *operational* meter accuracy—a subject, let me remind you, with which every Service Man worth the name must be familiar; and one which most Service Men acquire only through years of experience—than is available in any textbook heretofore published! Now let's continue.

"STANDARDIZATION RULES" OF A.I.E.E.

It has become common practice for instrument manufacturers to state the accuracy of their instruments on the basis of the *maximum error* which may occur at any part of the scale, but because of the reasons just discussed, this error is not expressed in terms of the *individual indications*. Instead, it is stated as a percentage of the *full-scale value of the meter range under consideration*. This gives a lower numerical value for the inaccuracy figure—but it is entirely correct (it is simply a more advantageous and fair way of expressing it) and is much more in keeping with the actual conditions under which meters are used in practice. This is in accordance with the Standardization Rules of the American Institute of Electrical Engineers.

When a manufacturer states that an instrument is accurate to within a certain percentage of the full-scale value of the range under consideration, it is understood to apply to the entire scale. In the type of instruments which have a uniformly-divided scale, this really amounts to saying that no scale division mark is out of its proper position by more than a certain *linear* distance (this linear distance being equal to the total scale length in inches multiplied by the % accuracy).

It might be mentioned here that if the meter scale were divided into 100 divisions, the error could be expressed in terms of scale divisions (2 for 2%, 5 for 5%, etc.). Therefore, the error would be expressed as so many per cent of full-scale *angular deflection*. This is particularly important, as we shall see later, when attempting to compute allowable error in ohmmeter ranges where the divisions are usually non-linear and the readings are from right to left (going up in resistance).

WHAT IS THE MEANING OF THE EXPRESSION: "ACCURATE TO WITHIN 2%?"

When a manufacturer specifies that a certain meter is accurate to, say within 2%, what does he mean? He always means that the actual *indication* of the meter itself (not as you may happen to read it if you are careless, and introduce additional *observational errors*) for any individual-range reading within its various ranges is *accurate to within plus or minus 2% of the full-scale value of the range which is being used*. It does not mean that the error will necessarily be as large as this at every point in the scale—it merely means that the error will not exceed this value. To make this clear, let us consider the following typical case:

Suppose a certain voltmeter has a 100-V. range (with a uniformly-divided scale up to 100 V.), and that its accuracy is stated to be within 2%. This accuracy rating means, simply, that for any voltage measurement made with this range, the indication of the meter pointer will be in error not more than (it may be less) $\pm 2\%$ (2% of 100). For instance, if the meter reads 100 V. when a measurement is being made, the true voltage might be as much as 2 V. above

(or below) this; i.e., some voltage between 98 and 102 V. Now if the reading happened to be, say, 50 V. instead, the true voltage might be as much as 2 V. (still 2% of the full scale of 100) above or below this, i.e., between 48 to 52 V.

If this same meter has, say a 50-V. range, the same 2% accuracy figure applies to this range also, but since it now applies to the full-range value of the 50 V., the possible volts error at any point on the scale is $\pm 2\%$ of 50, or $\pm 1\%$. For instance, if a reading of 50 V. were obtained on it, the true voltage might be as much as 1 V. (2% of 50) above (or below) this value, i.e., some voltage between 49 and 51 V. For a scale reading of say 20 V., the true voltage might be some value between 19 and 21 V., etc.

This important point should be remembered:

The meter accuracy figure stated by the manufacturer is based on the full-range value of the particular range used, and not on the actual value of a reading (except when the reading happens to be the full-scale reading).

Although a *voltmeter* was considered in our illustrative example, the same things hold true for *ammeters*, *milliammeters*, etc. The same rule also applies in those types of A.C. instruments that have scales which are not uniform. The stated accuracy in per cent is based on the full-scale value of the range being considered, regardless of what point on the scale the pointer actually is at. However, since the divisions at one end of such scales are very crowded (excepting in rectifier-type A.C. meters) such meters should never be read at the crowded part of the range if large *observational errors* are to be avoided.

In the case of *ohmmeters*, due to the fact that the meter scale is not uniformly divided and also because the full-scale end of the meter is usually the *zero ohms* end and *zero deflection* is *infinity ohms*, an actual, honest expression of the meter accuracy would be in terms of so many per cent of the full-scale *angular deflection*. That is, if a 2% accuracy is specified, this should be interpreted as meaning that the position of the pointer for any ohms measurement made on that range is accurate to within plus or minus 2 per cent of the full-scale *angular deflection*, the upper and lower limits being those expressed by the resistance values corresponding to pointer positions *off by 2%* (of the full-scale angular deflection) *above and below the measured value*. Therefore, with normal ohmmeter scales it is imperative to choose the range, such that the pointer deflection will fall somewhere between the $\frac{1}{2}$ and full-scale region, avoiding (as much as possible) measurements in the 1st $\frac{1}{5}$ and (if possible) the 2nd $\frac{1}{5}$ -scale regions.

DON'T CHECK YOUR METER THIS WAY

Service Men often present unjustified complaints to instrument manufacturers regarding the accuracy of their instruments—complaints which indicate a lack of complete knowledge of meter characteristics and meter accuracy. A favorite complaint (see Fig. 5A) which every instrument manufacturer receives regularly runs something like this:

"The voltmeter in my analyzer is not accurate. I tested all the voltage ranges on the same 110-volt line and I got a different voltage reading on every range—although I am sure the line voltage was steady. I don't see why the meter doesn't indicate 110 volts no matter which range I use. Doesn't this prove that the meter is not accurate?"

(Continued on page 422)

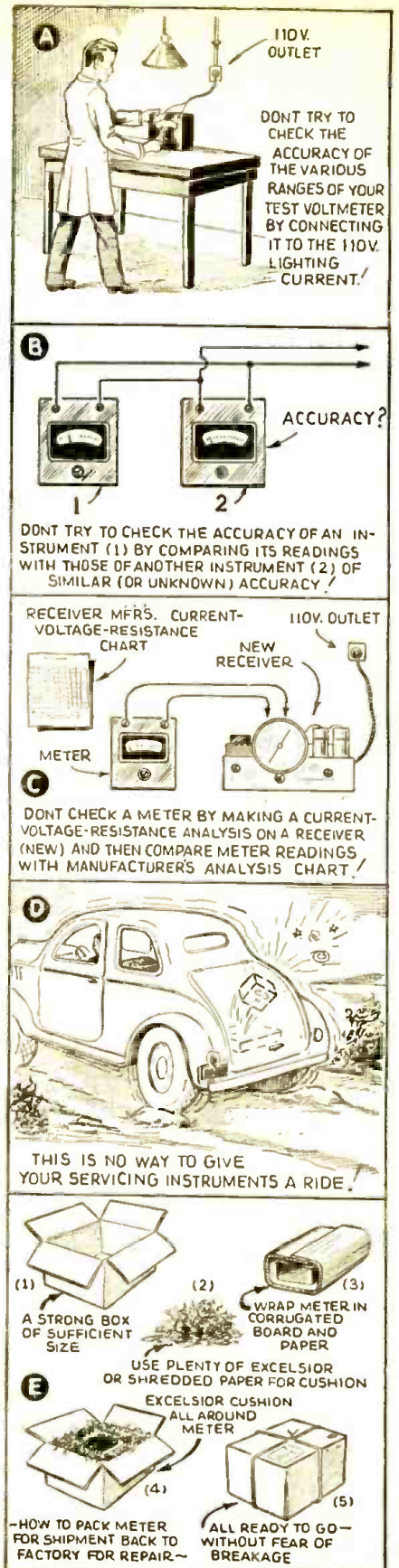

Fig. 5. A, any given voltage will not read identically on different scales of a meter; B, 2 meters connected in parallel in a given circuit will not read identically; C, don't check a meter against the normal operating voltages of a new set; D, this is no way to give your meters a ride; E, this is the only proper way of packing a delicate meter or instrument for shipment back to the factory.

"SNOW STATIC" BEING BEATEN BY "FLYING LABORATORY"

This article has been presented here in order to show radio men contemplating aircraft-radio work as a livelihood some of the problems encountered in obtaining noise-free radio reception for increased flying safety.

H. M. HUCKE.....PART III

LAST MONTH the various effects noticed when different types of electrodes were placed in the static field, of the "flying laboratory" during its many test flights, were discussed. Just how do these points now shape up with respect to each other?

INITIAL CONCLUSIONS

A grouping of these points suggested by Professor Starr gave the most orderly results. This group consisted of a pointed 2-ft. rod in the disturbed air at the tail; a pointed 2-ft. rod on the nose projecting into the undisturbed air ahead of the plane; and, a plate on the nose to record the impacting water particles.

A study of our data on all the points has resulted in the following conclusions:

(1) That the plane may be either positive or negative with respect to the surrounding cloud.

(2) That at any instant one wing may be in positive cloud particles while the other is in negative.

(3) That at any instant the nose of the plane may be in positive particles while the tail is in negative or vice versa.

The maximum cross-flow measured from wing-to-wing was about 500 microamperes though undoubtedly larger flows are possible. The maximum would constitute a stroke of lightning. There are many records of lightning strikes on all-metal planes which indicate wing-to-wing flows of several thousand amperes. During our flights we encountered one condition in a thundercloud in which the plane's magnetic compass moved 10 deg. with respect to the gyrocompass for a period of several minutes. This may have been due to a strong magnetic field in the cloud or to a cross-flow of current in the plane structure. Ground tests indicated that a wing-to-wing flow of about 45 D.C. amperes was required to produce the same compass deviation. A nose-to-tail current of 125 amperes produced the same effect. This would vary with the position of the plane with respect to the earth's magnetic field. Further tests with special wing constructions are needed to establish the magnitude of current flow through the plane.

ELECTRIC CHARGE IS DUE TO 6 VARIABLES

It is known that a negatively-charged point will go into corona about 50 per cent more readily than a positively-charged point. It is also known that the action of the propeller in cutting up water particles at a top speed of 800 ft. per second will produce an electric charge. It is reasonable to believe that the wing of a plane moving at 260 ft. per second will break up water particles and produce a charge. The electric charge recordings are, therefore, the summation of at least the following 6 variables:

- (1) The plus or minus charges of the water particles in the cloud which are collected by the wing foil.
- (2) The generation of charge due to the wing sections splitting water particles.
- (3) The generation of charge due to the propeller splitting water particles.
- (4) Foreign matter in the water particles (Portland, Oregon, tap water split by the rotating propeller gives a positive charge while Cheyenne, Wyoming, tap water gives a negative charge).
- (5) The rectification action of the test points with different polarity of the plane charge.
- (6) Cross-current flows due to the plane short-circuiting sections of cloud having different potentials.

From the above it is obvious that the mechanism by which the plane gathers an electrostatic charge is quite complex. Rather than spend valuable flight time trying to reach an orderly conclusion from this group of variables, it was believed best to proceed on to possible solution. In any case, it appeared probable that whether the plane became plus or minus it eventually reached a sufficiently high potential for corona discharges to appear on wing tips or any sharp projecting points. As a check on this assumption a tracing oscillograph connected to any of the test points gave typical corona discharge tracings whenever the characteristic sounds were heard in the plane's radio set.

CHARGING THE PLANE TO 100,000 VOLTS

The plane was charged up by a small Wimshurst machine while standing on the ground and by bringing a pointed ground wire near its structure, the characteristic snow-static sounds could be duplicated. Since this experi-

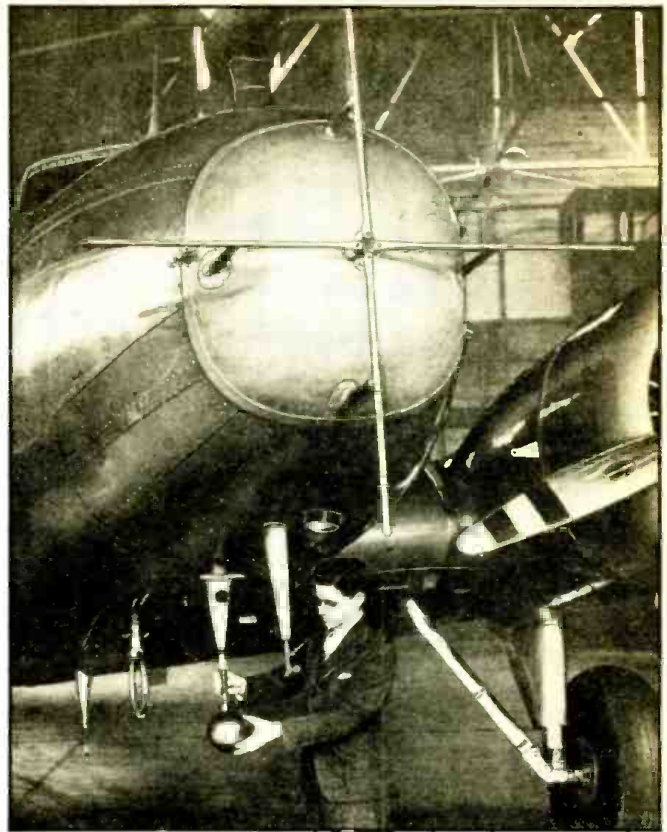

United Air Lines Communications Engineer H. M. Hucke under the nose of the company's "Flying Laboratory" with several of the experimental devices installed prior to flights to determine their efficiency in reducing static.

ment was limited by (1) the insulation of the rubber tires, (2) the A.C. modulation of the Wimshurst disc, and (3) the general variability of such a generator, a more substantial arrangement was desirable. Through the courtesy of the Westinghouse Company and Stanford University, we were able to borrow high-voltage insulators and assemble a 100,000 volt D.C. ray power supply. The plane was set up on these insulators in a large metal hangar and charged up to either plus or minus 100,000 V.

With this arrangement engineers could remain inside the all-metal plane with all radio equipment operating and use the test equipment in the same manner as was possible in flight. The tests further substantiated the corona discharge theory. The power was sufficient to make the anti-static loops and regular antennas inoperative in the same general ratio as had been observed on the test flights. The characteristic snow-static sounds were present.

Source of "Crying" Snow-Static. Static noise in the receivers with regular antennas began as low as 30,000 V., depending upon local humidity and the proximity of the artificial ground plane to the various points on the plane. The "crying" snow-static sounds usually began at about 55,000 V. and occurred more readily when the plane was positive with respect to ground. This crying phenomenon was readily traced to a corona discharge from some point on the plane. Artificial points were set up for its study and we concluded that the space charge in the ionized air around the point breaks down at an audio-frequency rate. This rate varies with the amount of moisture in the air and the voltage gradient at the point. Under controlled conditions it will produce any audio-frequency note. For example, on one test the noise produced followed the order shown in Table I.

TABLE I

Voltage	Characteristic Sound
55,000	noise like frying bacon
60,000	frying noise begins to pulse at about 10 cycles per second
62,000	frying noise pulses at 100 cycles
64,000	frying noise pulses at 500 cycles
66,000	frying noise pulses at 2,000 cycles
68,000	frying noise pulses at 8,000 cycles
70,000	frying noise pulses at 15,000 cycles
72,000	frying noise pulses at above audibility

At about this point some other point on the plane begins the same sounds and goes on up through the musical scale.

At any one time it will be possible for a number of points to produce this musical corona in any order. This, then, is the cause of the characteristic snow-static sound.

A study of the plane structure indicates that antenna masts, rivet heads, cotter keys, on aileron hinges and tail wheels, the antennas themselves and any sharp points on the plane are the focal points of the corona discharges and consequently the source of snow-static radio interference while in flight.

Unless these discharge points are quieted snow-static cannot be eliminated. Covering them with an insulator, reducing their sharpness, or covering them with a well-rounded corona shield will only allow the plane to build up to a still higher potential until some other point starts corona.

(Continued on page 428)

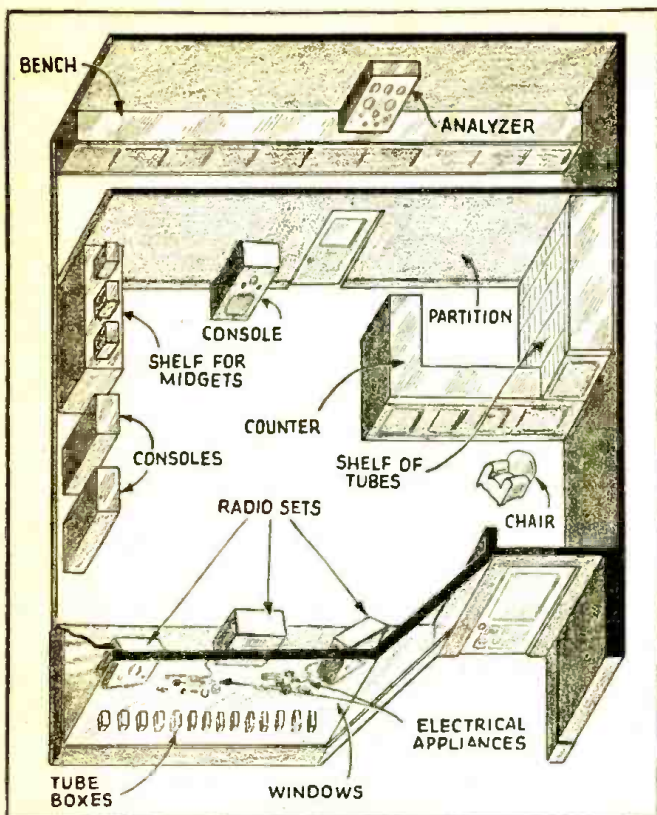

Fig. 1. Layout of the established radio store that was offered as an "out-standing bargain." What do you think of it?

THERE IS ALWAYS SOMEONE who wants to use the short-cut method of attaining an objective. As for example, a person purchasing an established business.

When purchasing an established business, it is generally considered that for the price paid, goodwill and an immediate income are obtained and the *HARD GRIND* of the beginner is eliminated. However, when a going establishment is for sale, there always must be a reason. Very often, a legitimate one, more often, just an excuse.

It is an excellent policy to be extremely cautious when purchasing a store. Do not hesitate to investigate every claim made by the party or parties offering the business for sale. It is advisable to have an accountant inspect the books and a lawyer to arrange for the terms of the lease. Remember—once you have paid, the place is yours and you may be "stuck" with it!

Let us consider the case of Mr. Degam as our "Business Problem" this month.

THE CASE OF MR. DEGAM

Mr. Degam was employed as an all 'round man by a well known concern in the down town section of a large city in the East. His duties were that of a carpenter, electrician, millwright, etc. He had a good deal of confidence in his mechanical abilities. As in all previous cases, ambition was a motivating factor for his desire to own a business of his own. Being very thorough, he took a resident course in radio servicing and made it a point to accumulate equipment, parts and accessories in easy stages, in preparation for an opportunity when it presented itself.

Knowing of Mr. Degam's plan, I was not surprised when he dropped in one day with a look on his face that indicated that at last Opportunity was knocking at his door. He was all excited and immediately started telling me about a friend of his who knew of a radio store that was for sale. The store was only a short distance from where he worked. He had seen the place and met the owner, whom he thought to be a very nice sort of fellow.

It seemed that Mr. W., the owner of the store, found himself in a predicament. Previously, his partner, wishing to complete an engineering course that he had dropped a couple of years ago, sold his interest to Mr. W. Shortly after this, Mr. W. received word that his father, who owned

BUSINESS PROBLEMS OF THE SERVICE MAN

The fourth in a series of articles on the problems of Service Men who anticipate branching out "on their own". The solutions offered in these articles are actual experiences of men whom "Jack" has advised.

Conducted by JACK GRAND

a large business was critically ill, and decided to turn his establishment over to his son. Mr. W. hated to part with his profitable radio business, but he could not operate the two at one time—a perfectly good reason for selling.

He had not really advertised the place for sale, but being that Mr. Degam was such a good friend of a friend of his, he would let him have the place at a very reasonable price—\$500!

I was further informed that Mr. W. was living in a very fine apartment, paying a high rent, had a nice new car, and was able to maintain a high standard of living. All—from the profits of the store.

Mr. Degam wanted to buy the place quickly before anyone else found out about this unusual opportunity.

Five hundred dollars is rather low for any business that can support one on the style claimed-for by Mr. W. and I commented on this point. This was passed off on the grounds that "Mr. W. was very anxious to leave town and could not hold out for any higher price."

I was requested to go with him and give the place and neighborhood the "once-over." So—I grabbed my hat—and we rode to the station nearest the store. Upon getting off, we stopped off at a restaurant for a bite. While eating, Mr. Degam was so enthusiastic about the place that he nearly sold it to me!

Coming out of the restaurant, the prospective purchaser of the radio shop started for the place immediately. I stopped him and suggested a walk around the neighborhood—just to look around.

While walking, I noted that for several blocks there were 1- and 2-family houses. About 5 blocks up there was the first apartment and I estimated that it housed about 40 families. Other apartment houses were scattered further along. Circling, I noticed a large hospital and a row of rooming houses. On the way back, we walked through a business street on which there were a number of empty stores. Another transit station was on the corner.

The store in question was in the middle of a long block between these 2 stations where pedestrian traffic was heavy mornings and evenings. Across the street from the store was an elementary school, further down nearer one of the transit stations was another radio shop and scattered along the block were more empty stores.

The competitor's radio store had a small, single window. He had on display a few tubes, several midgets, some electrical appliances, and house bulbs. Looking in, it was noticeable that the place contained very little merchandise.

Upon reaching the store to be purchased, I was requested to approach alone and make my observations. I, therefore, proceeded to look the place over. The front and depth of the place was a good deal larger than the competitor's, but it also displayed very little merchandise. There was a small console, some midgets, and accessories. The back of the window was of the open type allowing a clear view of the entire store.

There was a shelf on the left wall on which were a few small radio sets and on the floor 3 consoles were on display. The right side of the wall was bare for two-thirds of the length of the store. From here on, an L-shape counter

(Continued on page 442)

HOW TO CONDUCT A SOUND-ON-FILM RECORDING STUDIO

The studio described by Mr. Queen enables you to make (1) synchronized lectures, (2) theatre trailers, (3) news events reels, (4) screen tests, (5) recordings of scientific experiments, (6) home movies (reduced to 16 mm. size), (7) commercial or advertising pictures, (8) short featurettes, and (9) non-synchronized recordings.

THE STUDIO

I. QUEEN PART II

PART I OF this article described in detail the principles of the various methods of sound recording. Now, in this Part, we are ready to discuss the problems of setting up and maintaining the studio and the operation of a typical modern sound-recording outfit. This apparatus has been in continuous use for the past year in the production of talking trailers, screen tests, talkie news shots, etc. A double 35mm. recording system is used. The results have been excellent and compare favorably with regular feature productions.

ACOUSTICS

A knowledge of the principles of acoustics is of great importance for proper operation of a studio. In the case of talking pictures, sound-proofing is of even greater importance than in broadcasting. This is due to the fact that the microphone will usually be placed at a relatively greater distance from the subject, so that it will not be in the camera field. The ratio of original sound to reflected sound is thus greater. Also, the reverberation period of the theatre in which the film is projected is added to that of the recording studio, when the film is reproduced.

It is known that sound waves are reflected from most smooth surfaces. In the case of a closed room the sound is reflected from the several walls, ceiling and floor until the sound energy is dissipated. If the length of time between the start of the sound until it is inaudible is comparatively long, either a bad *reverberation* or an *echo* will result, that is, syllables will be superimposed over each other. Also, most rooms have a period at which they will resonate more freely than others. This also causes distortion of the sound input.

The remedy for this lies in sound-proofing. If the walls, ceiling and floor are covered with sound absorbent material, the energy will be quickly damped (transformed into heat energy). It is possible, however, to sound-proof a room to an excessive degree so that the room will sound "dead" and unnatural. Experiment usually determines how far sound-proofing can be carried.

Among the more commonly used materials, with their absorption co-efficients are the following (An open window is taken as 1. since it will absorb [that is, transmit] all the energy striking it and return [that is, reflect] none to the room.):

Acousti-celotex	.46
Rock wool	.80
Felt	.66
Velour	.45

An audience in the studio will greatly contribute to the absorption of sound, also. A carpet usually covers the floor where it will not lie in the camera field.

STUDIO TECHNIQUE

A typical studio would have approximately the following dimensions: 25 ft. wide, 45 ft. long and 15 ft. high. A larger
(Continued on page 430)



The author is shown monitoring a sound-on-film recording.



Everything in the studio is set to begin "shooting" the "talkie."

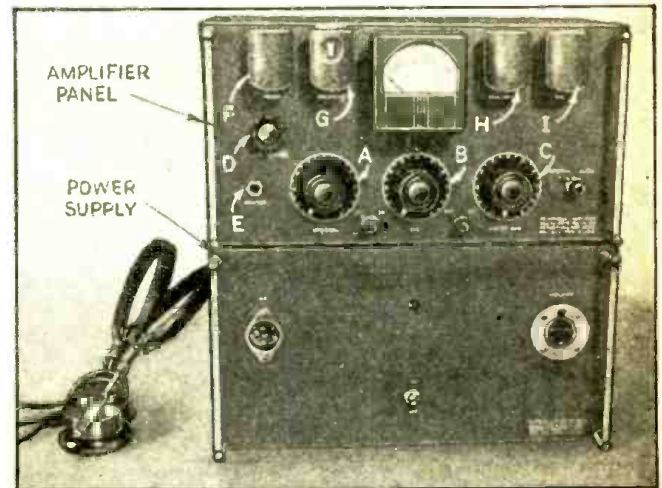

The amplifier and power supply of the sound-on-film recording apparatus. See text for details.

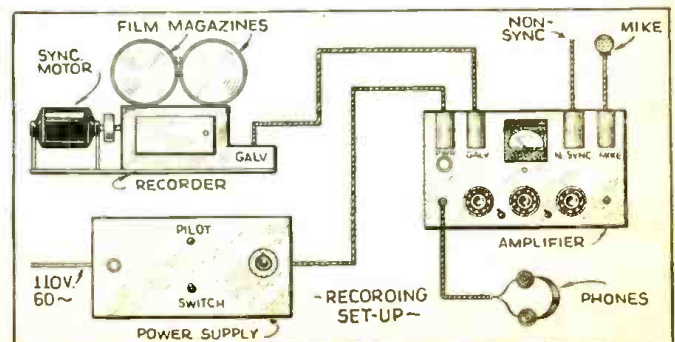
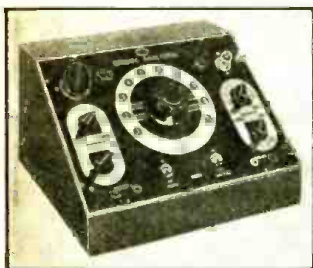

Fig. 3. Block diagram of the sound-on-film recording apparatus comprising recorder, amplifier and power supply.

THE LATEST RADIO EQUIPMENT

This department brings to you each month the newest developments in Electronic, Radio and Public-Address equipment. Aggressive technicians use this department to keep posted on the newer and better ways of doing things.



Newest bridge analyzer. (1507)



Portable sound system. (1511)



New D.C.-A.C. inverters. (1512)



Glass-dielectric condensers. (1513)

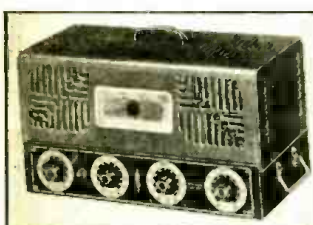

"Streamlined" amplifier. (1508)

IMPROVED CONDENSER-BRIDGE AND ANALYZER (1507)

IMPROVEMENTS in this make of servicing bridge and condenser analyzer, described in a past issue of *Radio-Craft*, are worthy of special notice. The A.C. bridge resistance-measurement circuit has a range of 1 ohm to 1 meg.; and capacity-test range of 10 mmf. and 100 mf.; an amplified and gain-controlled "electric eye" quickly shows balance. Dial calibration is linear and indicates in per cent. Utilizes 1-6G6, 1-6C6, 1-type ONA, and 1 special neon indicator tube.



Fast-service analyzer (1509)

NEW SOUND LINE FEATURES "STREAMLINE STYLING" (1508)

(Wholesale Radio Service Co., Inc.)

THE AMPLIFIER here illustrated is representative of a new line of amplifiers, of striking appearance, embodying "streamline styling." Steel protective covers are finished in platinum gray contrasting with a red plastic and chrome handle, chrome-finished nameplate and attractively designed louvers. Chassis and control panel finish is slate gray. Features: reverse feedback, automatic volume expansion, photo-cell input, individual bass-treble controls, variable A.V.C., and glow-lighted "neo" dials. Output powers range from 5 W. to 90 W.

Sound technicians now realize that equipment appearance plays an important part in favorably impressing clients.



Smallest velocity mike. (1510)

FAST-SERVICE ANALYZER (1509)

(Supreme Instruments Corp.)

THIS ANALYZER considerably reduces the time required to find radio trouble. By using this model 551 analyzer, which incorporates the exclusive Supreme system of free-reference analysis, it is possible to make all resistance, voltage and current measurements, between any 2 tube elements or between any tube element and ground (or chassis), on chassis top-side. If the user desires, he can still use the model 551 as a multimeter, as the unit has all the point-to-point functions and ranges of the model 541 set tester—20 in all—including the 0.2- to 1,400 A.C. voltage test; 0.2- to 1,400 D.C. V.; 0.2- to 140 D.C. ma.; and, 0.1-ohm to 20 megs.

This combination of ranges and functions, together with Supreme system of free-point analysis allows the Service Man to literally spread out the receiver's circuit on the analyzer panel, thus eliminating costly delays required by physically breaking each individual circuit for current measurements or fishing around underneath the chassis for point-to-point tests. Instrument measures 11 x 10½ x 4½ ins. high; and case, bronze panel, and all weigh 11 lbs.

SMALLEST VELOCITY MIKE (1510)

(Amperite Corp.)

COMPLETE with output transformer, this microphone is suitable for use as hand-, desk- or floor-type service. Response is said

to be flat from 60 to 7,500 c.p.s.; output is only 3 db. below the regular standard size velocity. Head measures 2¼ x 1 x 1¼ ins.; weight, 5½ ozs. Case is molded rubber. Rugged design.

The triple-service design of its mounting together with its small dimensions suggest this microphone as a particularly worthy addition to the equipment of the sound specialist.

6-V.—110-V. A.C. 20-WATT PORTABLE SOUND SYSTEM (1511)

THIS IS SAID to be one of the most complete portable sound systems so far developed.

Features: Single-speed phono motor and crystal pickup; the 20- to 30-W. amplifier has high gain; separate power packs permit either 6-V. D.C. or 110-V. A.C. operation; carrying space provided for records. Measures 19 x 14 x 10 ins. high.

NEW LINE OF D.C.-A.C. INVERTERS (1512)

OBTAINING 110 or 220 V. 60 cycles from either 6 or 12 V. D.C. is a simple proposition when one of these vibrator-type inverters is used. By its application all sorts of standard 110 or 220 V. A.C. equipment—radio sets, public-address systems, electrical testing equipment, and even medical apparatus—may be operated from an ordinary storage battery. Dimensions: 7¼ x 8 x 4½ ins. high; weight, 17 lbs.

(Continued on page 443)

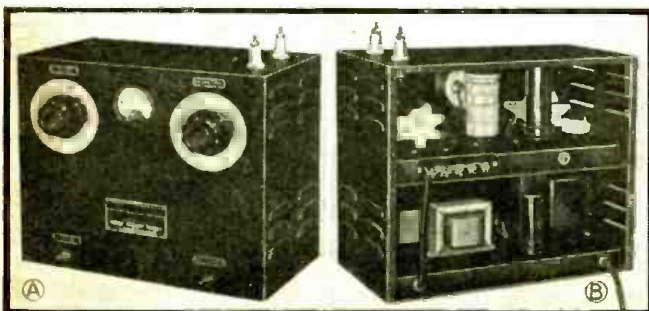

Kit-type 25-W. transmitter. (1514)

(Here, shown in front and back views, is a "build your own" S.-W. transmitter.)



High-quality recorder. (1515)

Name and address of any manufacturer will be sent on receipt of self-addressed, stamped envelope. Kindly give (number) in above description of device.



Multi-type test instrument has eye appeal. Employs R.M.A.-spec. test of tubes, resistors, condensers. (1516)



Types EA (left), and Jumbo filter units. (1520)



Newest test speaker. (1521)



"Hi-formation" electrolytic. (1522)

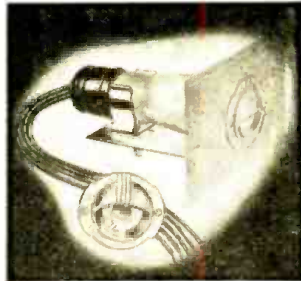

Tuning "eye" assembly, built-in target-to-plate resistor. (1517)

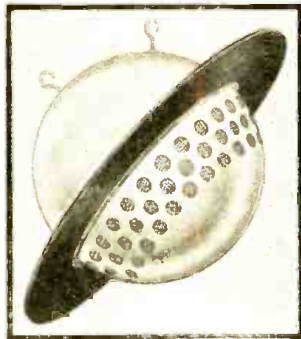

Mounting this sphere-speaker from hook as shown, affects directional coverage; using hook shown in left corner provides projection directly downward. (1518)



High-voltage condenser (1519)

DELUXE COUNTER-TYPE MULTI-TESTER (1516)

(Radio City Products Co.)

THIS ATTRACTIVE test unit utilizes one of the new rectangular meters; 4 multi-color dials permit easy direct-reading tests of tubes, resistors and condensers. Tests all tubes under R.M.A. specifications. Tube-type rectifier circuit utilized. Ohmmeter range, 0/10,000 ohms/1 meg. Capacity range is 0.001/0.4/16 mf. Neon condenser leakage test. Hot inter-element tube short and leakage tests. Also available in combination portable and counter case; and in kit form. Designed to afford exceptional performance at low cost.

TUNING "EYE" MOUNTING ASSEMBLY (1517)

AN ASSEMBLY that makes possible the application of the electron-ray tube or tuning "eye" to sets employing automatic volume control but lacking a tuning indicator is now available. An adjustable spring clip, that holds the tube, accommodates various panel thicknesses. The requisite 1-meg. target-to-plate resistor is built into the assembly which is also provided with a 22-in., 5-wire, color-coded cable.

SPHERICAL-SHAPE LOUDSPEAKER (1518)

THE MANUFACTURER of this unique, modernistic "Saturn" loudspeaker particularly recommends it for use as a P.A. and extension unit. Suspension hooks permit choice of forward or downward sound diffusion. The satin-finish aluminum ball, with its trim of a "ring of Saturn," has ample space for the 12-in. speaker and diffuser unit.

PORCELAIN-CASE HIGH-VOLT MICA CONDENSER (1519)

(Aerovox Corp.)

A CONDENSER that will stand high voltages and high frequencies is often required for various services; either or both characteristics may be desirable in certain

types of amplifiers, television and electronic equipment, and transmitters. This demand is met by a line of recently-announced porcelain-case, mica-insulated condensers. Capacity range—50 mmf. to 0.1-mf. D.C. test voltage range—2,000 to 12,500. Various maximum R.F. current capacities are available.

JR and KR etched-foil electrolytic condensers.

Other features include "surgical cleanliness" in handling assembly to prevent internal corrosion, triple-sealed cartons, and anchored flexible leads. The characteristics of these condenser types make them of special interest to Service Men and experimenters.

IMPROVED NOISE ELIMINATORS (1520)

(Solar Mfg. Corp.)

TO OVERCOME interference caused by electric-type razors, the type AE Elim-O-Stat has been developed by a well-known manufacturer. This Elim-O-Stat is a filter of the capacitive-inductive type containing not only the conventional condensers usually used in devices of this kind but also induction coils for maximum filtering effect. Installation of these units is usually made by means of built-in plugs.

The Jumbo Elim-O-Stat is a more effective capacitive-inductive filter having more universal application. Designed to eliminate interference either at the electrical appliance or at the radio set.

NEW P.M.-TYPE MULTI-TEST SPEAKER (1521)

(Wright-DeCoster, Inc.)

HERE is a test speaker that permits checking the reproducer performance of A.C. and D.C. radio sets of all types including electric, and car-radio and home battery receivers. Switches afford matching of field coil and output transformer.

IMPROVED ELECTROLYTICS USE HI-FORMATION PROCESS (1522)

(Cornell-Dubilier Electric Corp.)

A MECHANICAL film that is "tougher," thus allowing for greater voltage surges and rapid healing, is obtained in one make of electrolytic condensers by using a patented development known as the "hi-formation process." This system has been applied to the types

NEW HIGH-EFFICIENCY ALL-WAVE ANTENNA KIT (1523)

(RCA Manufacturing Co., Inc.)

THIS EFFICIENT antenna is of the balanced-doublet type and affords unusually efficient pick-up over the very wide frequency range of 140 to 23,000 kc. A new type transmission line is utilized; a unit at either end couples antenna to line, and line to receiver. Will operate with all types and makes of receivers. Kit is sold pre-assembled.

Early types of doublet all-wave antennas were not uniformly efficient over a wide frequency range. Continued research however has surmounted many problems so that today's antennas may well replace earlier installations.

"EXACT-DUPLICATE" REPLACEMENT TRANSFORMERS (1524)

IF EXACT electrical requirements of 1,200 A.C. sets listed in one service manual were to be met, the Service Man would need to stock 800 different power transformers, according to one survey. In consequence, a well-known transformer manufacturer has found it possible to produce a line of 18 "exact duplicate replacement transformers" that adequately meet the requirements of the original 800 factory types. Long flexible leads, R.M.A. color-coded, are used; static shields reduce line noise to a minimum. Special mounting brackets fit the respective "exact-duplicate" replacement transformer to original chassis holes for (A) narrow-vertical, (B) wide-vertical, and (C) horizontal or half-shell mounting; these 3 mechanical variations are illustrated.

(Continued on page 445)



Newest high-efficiency all-wave antenna kit. (1523)

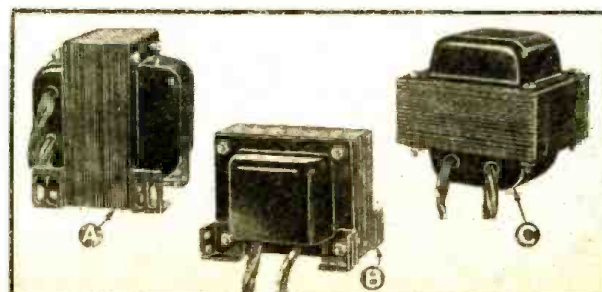

"Basic" transformers (A, B, C) exactly replace 1,200, in A.C. sets. (1524)

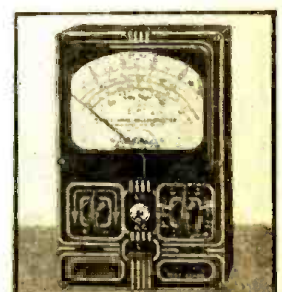

New multi-meter. (1525)

INTERNATIONAL-KADETTE MODEL 1019 A.C. SUPERHET.

Ten-tube (including 3 ballast tubes) superhet.; 2 bands; A.C. voltage-doubling circuit; quiet automatic volume control; operates on 110-125 V. 25-60 cycle A.C. only.

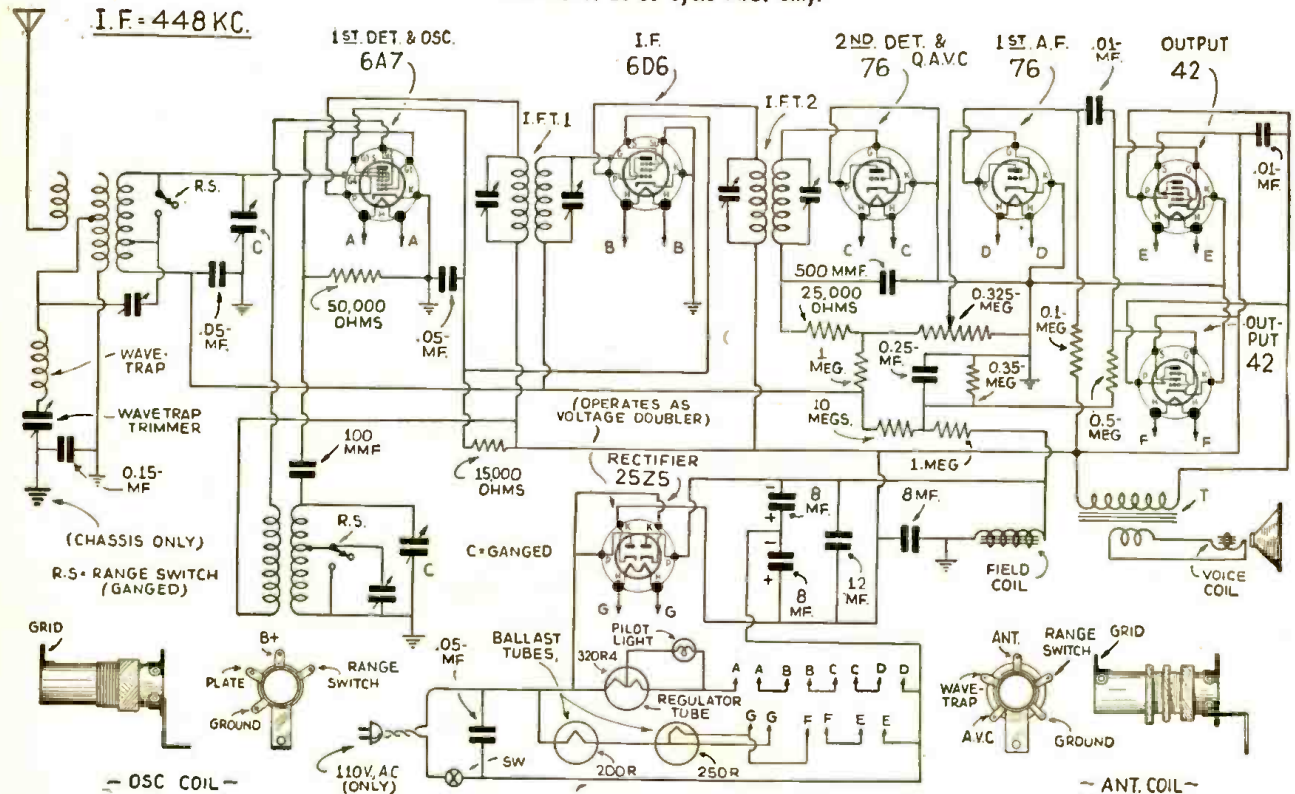

This diagram of a dual-range A.C. set introduces a new type of quiet A.V.C., a regulator and 2 ballast tubes, and a practical voltage doubler circuit.

This chassis is designed to operate from 110-125 V., 50-60 cycle alternating current power lines. It is a 2-band receiver covering the American broadcast band and police, airport and 49-meter European bands.

ALIGNMENT

Essential Data: The intermediate frequency employed is 448 kc. The standard type of output meter should be used to indicate signal strength. It should be connected from the plate of the 41 tubes to ground. Poor sensitivity may be an indication of incorrectly-adjusted I.F. trimmers. Aligning of broadcast band should be done on 1,400, 1,000 and 600 kc.

Intermediates: To align the I.F. circuits, set the signal generator to 448 kc. and feed its modulated signal direct to the antenna. Adjust the 1st I.F. transformer trimmers for maximum meter reading. Go over both adjustments at least 3 or 4 times for accuracy. Repeat this process on the 2nd I.F. transformer. If adjustments are not made accurately, selectivity will be poor and I.F. oscillation may result. Finally, adjust the trimmer in the tuned wave trap for minimum meter reading.

SHORT-WAVE BAND

Turn the dial to 6,000 kc. and feed a very weak 6,000 kc. modulated signal from your signal generator to the antenna. Adjust the short-wave oscillator trimmer for maximum reading. Then peak antenna

coupling condenser to this oscillator setting. Do not attempt to align the low-frequency end of this band.

BROADCAST BAND

Turn the dial to 1,400 kc. and feed a very weak 1,400 kc. modulated signal to the antenna. Adjust broadcast oscillator trimmer for maximum reading. Then peak broadcast antenna trimmer to this oscillator setting. There is no adjustable paddler condenser in this model so resonance on lower frequencies is accomplished by bending plates on tuning condenser.

AVERAGE SOCKET VOLTAGES

Tube	Position	Ek	Eg	Ega	Egs	Esu	Ep
6A7	Det.-Osc.	0	*-1.5	165	90	—	165
6D6	I.F.	0	*-1.5	—	90	0	165
76	2nd Det.	0	*-.45	—	—	—	0
76	1st Audio	0	†	—	—	—	†35
41	Output	0	*-12.5	—	165	—	160
41	Output	0	*-12.5	—	165	—	160
25Z5	Rect.	165	—	—	—	—	AC

Line voltage 118 volts, 10% variation allowable. Measurements made from tube prong to circuit ground with 1,000 ohms/volt instrument on 250 V. scale.

*Not measurable; calculate from 50 V. drop across speaker field. †Through 0.1-meg. ‡Diode biased.

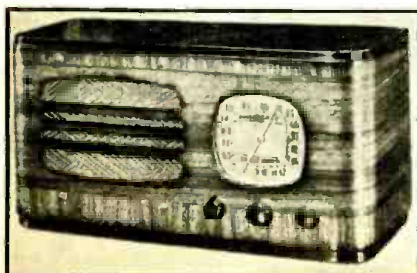

Compact mantel set with many features.



Tube arrangement, etc.

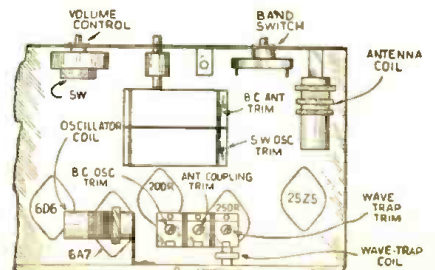

Locations of trimmers.

CROSLY FIVER CHASSIS "CHAIRSIDE" MODEL 567

5-tube superhet.; 2 bands (540-1720 kc. and 5800-15,400 kc.); automatic volume control; 2 W. output; Mirro-Dial; 5-in. dynamic speaker.

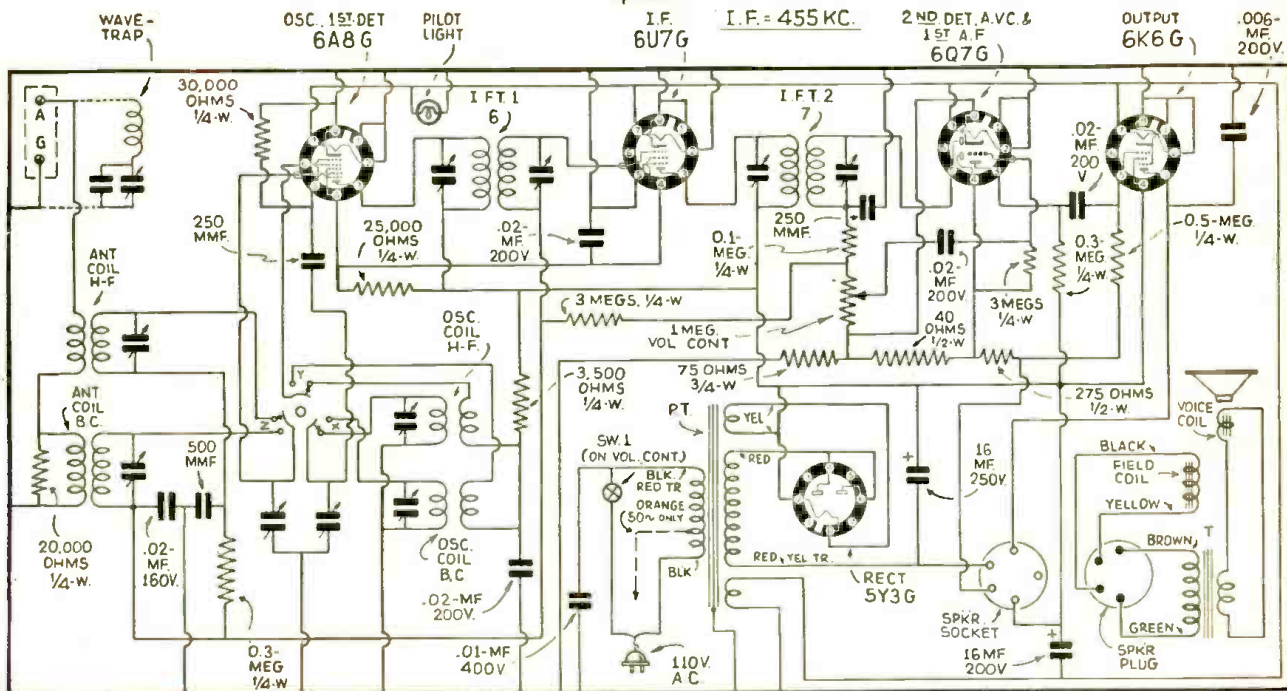

Schematic diagram of the Crosley (Fiver) model 567 receiver.

ALIGNMENT PROCEDURE

Connecting Output Meter. Connect the output meter to P and S of the 6K6G output tube. Be certain that the meter is protected from D.C. by connecting a condenser (0.1-mf. or larger—not electrolytic) in series with one of the leads.

Tuning I.F. Amplifier to 455 kc. (a) Connect the output of the modulated signal generator through a 0.02-mf. condenser to the top cap of the 6A8G tube, leaving the tube's grid clip in place. Connect the ground lead from the signal generator to the "GND" terminal of the receiver. **KEEP THE GENERATOR LEADS AS FAR AS POSSIBLE FROM THE GRID LEADS OF THE OTHER SCREEN-GRID TUBES.** (b) Set the station selector so that the tuning condenser plates are completely out of mesh and turn the volume control knob to the right (ON). (c) Turn the band selector switch to the left (broadcast band). (d) Set the signal generator to 455 kc. (e) Adjust both trimmers located on top of the 2nd I.F. transformer for maximum output.

ALWAYS USE THE LOWEST SIGNAL GENERATOR OUTPUT THAT WILL GIVE A REASONABLE READING ON THE OUTPUT METER.

Aligning the R.F. Amplifier. When aligning the R.F. amplifier the output lead from the signal generator is connected to the antenna (A) terminal of the receiver. For the broadcast band a 250 mmf. condenser should be connected in series with the output lead of the signal generator and for the high-frequency band a 400-ohm carbon resistor should be used in place of the condenser.

(a) With the station selector adjusted so that the tuning condenser plates are completely out of mesh and the band selector switch set to the band being aligned, adjust the "OSC" shunt trimmer so that the minimum capacity signal (C), is heard. It is not necessary that the receiver tune through this signal.

(b) Adjust the station selector so that the shunt alignment signal is tuned-in with maximum output. Then adjust the "ANT" shunt trimmer for maximum output. Readjust the station selector slightly so that the generator signal is tuned-in with maximum output and check the adjustment of the "ANT" trimmer. **Do not readjust the "OSC" trimmer.**

Note 1: When shunt aligning the high-frequency band care should be exercised so that the circuits will be aligned on the correct frequency rather than on the image frequency which is approximately 910 kc. less than the fundamental. To check on this, increase the output of the signal generator 10 times, or more, and try to tune-in the signal both at the generator frequency as indicated on the station selector dial and at approximately 910 kc. less than the correct frequency. If the circuits have been properly aligned the signal can be tuned-in at both spots but stronger at the correct frequency.

The tube socket voltages are measured from the tube socket contacts to the chassis with a 1,000 ohms/volt 500-V. D.C. voltmeter (except filaments) with the receiver in operating condition and no signal input. The filament voltages should be measured with an accurate low-range A.C. voltmeter (approximately 0-10 V.). Readings may vary plus or minus 10 per cent of values given.

TUBE SOCKET VOLTAGE READINGS						
Tube	Function	H	P	S	K	G
6A8G	Oscillator-Modulator	6.3	160	115	0	-1.2
6U7G	I.F. Amplifier	6.3	160	115	0	-1.2
6Q7G	Diode Detector & A.F. Amplifier	6.3	80	—	2.5	-2.5
6K6G	Output	6.3	160	160	0	-5.0
5Y3G	Rectifier	5.0	—	—	225	—

Power output approximately 2 W. Power consumption approximately 40 W. at 117.5 V. Voltage drop across speaker field 35 V.

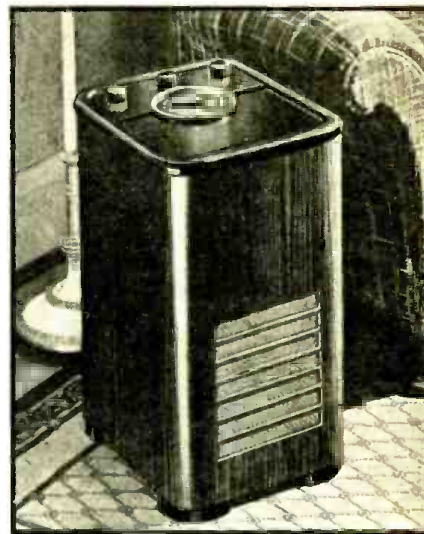

The Crosley Fiver Chairside model (chassis 567).

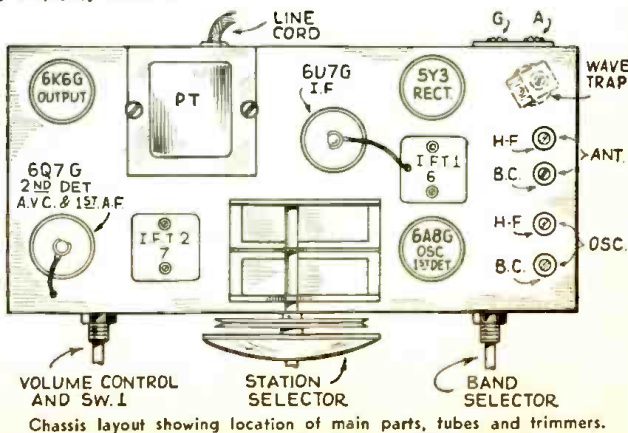

OFFICIAL RADIO SERVICE MEN'S ASSOCIATION, INC.

MEMBERS' FORUM

A department devoted to members and those interested in the Official Radio Service Men's Association. For mutual benefit, contribute *your* kinks, gossip and notes of interest to Service Men, or others interested in servicing.

WE, THE UNDERSIGNED—!

RADIO-CRAFT, ORSMA, Dept.:

We, the undersigned, agree with Mr. F. D. Buchanan, Owatonna, Minn., that all Service Men should be licensed. This card is only to show how we feel as we are too busy to write a letter.

GUILFORD RADIO SER.
SUPER RADIO: AND.
F. J. WESTERKAM,
Baltimore, Md.

SCHOOL GRADUATE VS. EXPERT

RADIO-CRAFT, ORSMA, Dept.:

I have taken *Radio-Craft* for some time, and I am very interested in what other Service Men have to say. Some of their arguments are good and some not so good.

Some time ago I read the articles by Mrs. Iodice and F. D. Buchanan, concerning the Service Profession, and take this opportunity to comment concerning them.

All Buchanan harped on was making the Service Man take an examination and soaking him \$15 a year dues. Well, as you know, that is out of the question. (I mean the \$15). Now, as for Mrs. Iodice downing the "correspondence course, supposed-to-be-Radio Man," it happens that I took a course in one of the biggest schools in Los Angeles, and I finished several months ago. My test equipment to date consists of one Supreme 385 automatic tester and one Supreme oscillator, and as yet I have not been able to

Here is the shop layout of Mylo H. Candee, ORSMA Member No. 18703, of Pasco, Washington. From the busy appearance of his bench, Mylo is not wanting for business. In addition to this radio shop he also owns a nifty P.A. sound truck which he rents out for various occasions. There's certainly no grass growing under Mylo's feet! Good luck and yours for continued good business.

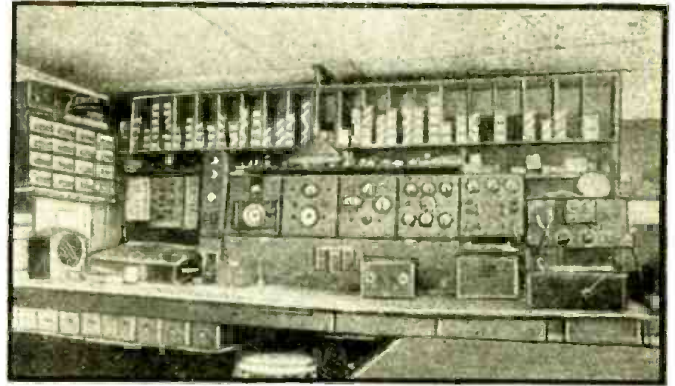

buy a "scope", but I am more equipped than some of these shops that have been in business for 5 years or more. This school requires that each student buy his own equipment, if possible while we are in school.

Now, here in our fair City of Los Angeles, we have a Radio Association, and to join it we have to pass both a theory and a practical examination. Now, not tending to brag, I passed this said examination, which some of these so-called "EXPERTS" failed on. So because we happened to be school graduated, we should be kept out of the radio field? Where did these other

radio experts learn their trade if not by studying some correspondence course or going to school? Because you have had 10 years experience is no sign that you are so "hot." Give us new men a chance and maybe in 10 years we will know more than you do now. In my several months out of school I have held one steady job in a radio shop, and I have had to repair sets that some of the "wise men" have failed to fix—and I made them work.

Three days ago I received a Majestic 70 that an experienced man had to return unfinished
(Continued on page 440)



FREE — A 1-year subscription to RADIO-CRAFT to each person who submits a WITTIQUIZ that in the opinion of the Editors is suitable for publication in RADIO-CRAFT. Read the following WITTIQUIZZES; can you spot the correct answers? Now send in YOUR idea of one or more good WITTIQUIZZES based on some term used in radio, and win an award. (Contest rules at end of dept.)

(39) A *candohm* is—

(a) A Canadian ohm. (b) A special type of wire-wound resistor protected by a metal shield. (c) A new type beer container. (d) Ten million ohms.

RALPH L. GREEN

(40) All expert radio men know that *henry* is—

(a) A good sport. (b) A unit of measurement for inductance. (c) A hen-pecked husband. (d) Used as a unit of measurement for amplification.

J. I. STANGL

(41) We hear that a *filter* is—

(a) A small can filled with sand, through which the grid leak is allowed to flow. (b) A device for detecting leaky condensers. (c) A system for separating A.C. components from D.C. supplies. (d) A gadget to prevent moisture accumulating in a radio set. (e) A contrivance for purifying the electron stream.

(42) It is not news that a *choke* is—

(a) A device to prevent advertising ballyhoos coming through the loudspeaker. (b) A coil of wire that offers high resistance to A.C. and low resistance to D.C. (c) A contrivance to regulate the flow of air through air-tuned intermediates. (d) A device to blow the dust from a radio chassis.

G. W. RUMRILL

(43) The expression *auto-induction* means—

(a) To introduce a new line of automobiles. (b) A voltage induced into a secondary winding, by a primary one. (c) That auto prices are reduced. (d) A voltage generated in a same winding, which established the magnetic field in the first place.

(44) The *amplitude* of a sound wave determines—

(a) The pitch of the sound wave. (b) Intensity or loudness of the sound. (c) The wavelength of the waves. (d) The static-like noise which accompanies the radio programs.

MASAO SERA

(45) A *choke* coil is—

(a) A primitive implement of execution. (b) A coil wound tightly on a tube shield to absorb stray currents. (c) A coil used to offer high impedance to an alternating current.

ROBERT E. HARRISON

(46) Every Service Man knows that a *rectifier tube* is—

(a) A tube connected in series with the key of a transmitter to rectify any mistakes which the operator may make in sending. (b) An automatic tone control tube. (c) A tube for transforming A.C. into pulsating D.C. (d) A photoelectric cell in a cashier's window to rectify any mistakes in making change.

(47) Of course you know that *frequency drift* is—

(a) A drifting of seaweed in the Sargasso Sea which interferes with radio reception in that area. (b) A series of random frequencies which drift around from place to place after a thunder storm. (c) The gradual change in frequency of a carrier wave.

(48) It is a well-known fact that a *tube* is saturated when—

(a) There is too much water in the bulb. (b) The filament has soaked up too much moisture. (c) The grid is biased strongly negative. (d) All the electrons emitted by the cathode are drawn over to the anode.

(49) If you saw the words *detector tube*, you would know that they referred to—

(a) A tube used by the F.C.C. to detect any stations which are operating off-frequency. (b) A tube for rectifying the inaudible radio-frequency input into audio frequency which may be heard in the headphones. (c) A tube used in modern radio sets to detect mice which may nest in the cabinet. (d) The audio output tube in a superhet.

LESTER KEENE

(50) A *power detector* is—

(a) An employee of an electric company who checks meters to see if people are surreptitiously appropriating power. (b) An instrument for
(Continued on page 442)

LATEST TONE-CONTROLLED ELECTRONIC PIANO

(Continued from page 402)

A foot-operated volume control is provided to give an effect similar to the swell pedal on an organ. This is something long desired by pianists but never satisfactorily provided. The instrument will be available in any standard piano case adapted to the new console pianos. A small, plain, external cabinet (see Fig. C) houses the reproducer and power amplifier.

POSITION OF PICK-UP DETERMINES HARMONIC CONTENT

Acoustic research showed that when one note on a piano is struck, the other notes (although supposedly "dead"), through the mutual coupling of the sounding board, exerted a tone-modifying effect on the "speaking" string. It was found desirable, in order to maintain the characteristic piano tone, to mechanically couple all the strings together by passing one end over a bridge which is spring-suspended.

The springs consist of transverse bars anchored at their ends to the frame of the piano and supporting the bridge near their centers. Inasmuch as similar bars are used to support the sounding board, this gives a structure surprisingly like an acoustic piano with the sounding board omitted.

A string will vibrate not only as a whole at the fundamental, but also in 2, 3, 4 and more integral segments corresponding to the harmonic series. If the pick-up is placed opposite a node of a certain harmonic, that is, where there is no vibration due to this harmonic, then this harmonic is not translated. Therefore, the point of pick-up must be carefully chosen to give just the harmonic content that is desired.

HOW THE ELECTRONIC PIANO PERMITS SIMULATING ORGAN

Many musical tones differ only in their envelope. For example, the harmonic content of a piano is remarkably similar to that of certain of the woodwinds. But for the envelopes—as shown in Fig. 1B—they are quite similar. If the volume immediately following the hammer impact could be slowly built up instead of rapidly falling off, the tone would have an organ-like quality. This can be achieved by striking a note with the swell pedal in the "low" position and immediately thereafter raising the volume, so that this technique is not hard to acquire, and a certain well-known organist, without being told of the possibility of this effect, found it for himself and put it to good use within 5 minutes after first seeing the instrument.

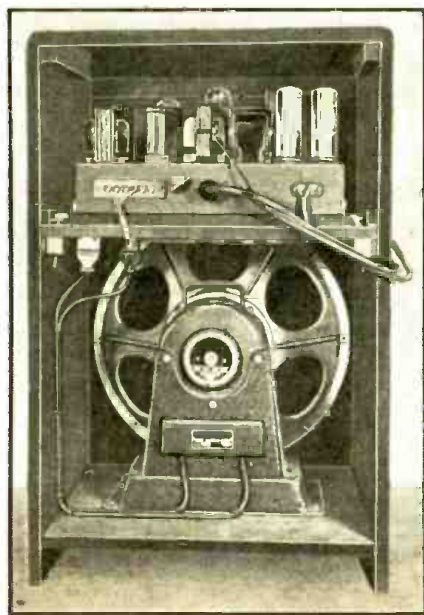

Fig. C. View inside the cabinet showing the location of the amplifier and speaker. As shown in Fig. 1A (page 402) the volume control on the amplifier is foot-operated, thus providing a "swell" pedal similar to that of an organ. This electric piano duplicates the acoustic characteristics of the mechanical piano which has a sounding board.

SUPERIOR VALUE IN SUPERIOR INSTRUMENTS MAKES YOU WANT SUPERIOR'S TEST EQUIPMENT!

MR. SERVICEMAN—You can't afford to overlook the values in SUPERIOR'S instrument line. Such outstandingly low prices for equipment that has gained rapid popularity proves that service shops are being equipped with SUPERIOR'S stationary and portable servicing instruments. This advertisement is your buying guide . . . use it to your advantage!

27 Instruments in 1 THE ALLMETER 1,000 OHMS PER VOLT



The ALLMETER permits both A.C. and D.C. measurements for volts and currents, also low resistances from below one ohm, also high resistance capacitors, strays and dielectrics, comprising 27 instruments in one.

- 1—A.C. Currents, 15-150-750 ma. This extremely valuable service is practically never afforded by multitest instruments.
- 2—A.C. Currents, 15-150-750 volts. Affords also output meter service. Instruments, 3.
- 3—CAPACITY, .01-50 mfd., all condensers, including electrolytics. Instruments, 1.
- 4—5-1,000 Henries, coil loaded or not. Instruments, 1.
- 5—LOW ohms, .03-500 ohms. Extremely valuable. Instruments, 1.
- 6—HIGH ohms, to 0.5 meg., covering all practical values. Instruments, 1.
- 7—D.C. Volts, 10-150-750 volts. Simplified scale uses same calibration as for field scale. Instruments, 3.
- 8—D.C. Currents, 15-150-750 ma. The same scale simplification, also 0-1 milliamperes. Instruments, 4.
- 9—Decibels, -12 to +10. Instruments, 3 + 8 = +30 (by interpolation) + 8 + 50 by interpolation.
- 10—Vacuum-tube voltmeter, 0-15-150-750 volts A.C. D.C. Instruments, 6.
- 11—Continuity tester. Instruments, 1.

Shipping wt. 8 lbs. Net price \$10.40

THE RC BOX SOLVES PUZZLING PROBLEMS IN CAPACITY AND RESISTANCE REPLACEMENTS; ALSO USEFUL AS STANDARDS OF CAPACITY AND RESISTANCE



SPECIFICATIONS

Direct-reading, 0-40 ohms, at 10 watts maximum allowable power dissipation ● Direct-reading, 0-20,000 ohms, at 3 watts maximum allowable power dissipation ● Direct-reading, 0-1,000,000 ohms (1 meg.), at 1 watt maximum allowable power dissipation ● Direct-reading, 10-100 mfd. (.0001 to .0001 mfd.) ● Direct-reading, 10-100 mfd. maximum ● Direct-reading, at 200 peak volts allowable maximum ● Direct-reading, 100-450 mmfd. (.0001-0.001 mfd.), at 200 peak volts allowable maximum ● Calibrated values, including wire-winding of the 40 and 20,000-ohm units ● Tuning condensers of exceptional quality (excellent power factor) ● Two separate binclearly designated. (Rotor of two-gang condenser is common to two posts, upper left and upper right) ● Accuracy is 2 per cent for all capacity settings, also for all settings of the 40 and 20,000-ohm resistors; 5 per cent for the 1,000,000-ohm unit ● Instrument is totally shielded, so that spurious effects due to stray pickups, affecting capacity measurements particularly, are avoided. One of the common rotor denser may be used as ground when the other condenser or any of the resistors is being used. Overall size of instrument is 10 x 6 1/2 x 4 inches ● Black wrinkle finish cabinet has carrying handle. Net price \$6.10

Shipping weight 4 lbs.

VOLT-OHM-MILLIAMMETER



The HANDI-METER, a new volt-ohm-milliammeter, enables direct readings of d.c. volts, 0.5-50/500 ohms, 500/20,000 millivolts, likewise direct-reading, and d.c. current, likewise direct-reading, to 20 amperes. Low ohm scale enables a.f. coils, r.f. and i.f. as well as a.f. coils, instruments never before included low ohm range, reading to one ohm, nor did they have an adjuster for accuracy of ohm readings. Complete with test leads and self-contained batteries. Shipping weight 5 lbs. Net price \$4.10

GENEMETER



WITH VARIABLE AUDIO FREQUENCIES

\$14.40

Complete with Four Tubes

- Combination R.F. and Audio Signal Generator, R.F. 100 KC. to 105 M.C. A.F. 25-10,000 cycles, air direct reading, 50 by front panel switching.
- R.F. and A.F. outputs independently obtainable alone, or with A.F. (any frequency) modulating.
- Output meter for connection across primary of receivers' output transformer for peaking with leakage is minimum.
- Condenser and other leakages tested to 100 megohms.
- Main dial graduated on 7 1/2" diameter, and 4-1 vernier diametric drive.
- All services on 0-130 volts a.c. or d.c.

Shipping weight 10 lbs.



FREE Catalog!

MODEL V-45 TUBE TESTER



Emission type perfected tube tester for any and all type receiver tubes, including metal and metal-glass. Tests shorts and leakage. Accurate, simple, sturdy, direct

— English — reading \$10.40 (Bad-Good).

Shipping weight 9 lbs.

SUPERIOR INSTRUMENT COMPANY
136 LIBERTY STREET DEPT. N NEW YORK, N. Y.

HOW DEPENDABLE ARE YOUR METER READINGS?

(Continued from page 412)

Let us see why it is perfectly natural for this man to get a different reading on each range of his voltmeter even though the voltage being measured is exactly 110 volts in each case!

Let us assume that his meter has the usual 2% accuracy, and that it has ranges of 0/7/35/140/350/700/1400 V. Remember, that the manufacturer's guarantee that the meter is accurate within 2 per cent means that on each range, it is accurate to within 2 per cent of the full-scale value of that range. On the 7-V. range, for instance, the meter is accurate within 2% x 7 = ± 0.14-V. at any point on the scale; on the 35-V. scale, it is accurate to within 2% x 35 = ± 0.7-V. at any point on the scale, etc. The possible amounts by which readings may be off on each of the rest of the ranges were calculated in the same way, and all are arranged in

TABLE I.

Range	Voltage-Tolerance
7 V.	± 0.14-V.
35 V.	± 0.7-V.
140 V.	± 2.8-V.
350 V.	± 7.0-V.
700 V.	± 14.0-V.
1,400 V.	± 28.0-V.

Therefore, since the meter is accurate to within 2% when the 140-V. range is connected to the 110-V. voltage source, the meter may properly indicate anything between 107.2 (110 minus 2.8) and 112.8 (110 plus 2.8) V.! If the 350-V. range is connected to the same 110-V. source, the reading might properly be anything between 103 (110 minus 7) and 117 (110 plus 7) V.! On the 700-V. range, the reading might properly be anything between 96 and 124 V. On the 1,400-V. range, the reading might properly be anything between 82 and 138 V.! If any such readings were obtained, the meter could not be considered as being beyond its specified accuracy!

Therefore, the fault lies, not with the meter, but with the Service Man. He is not making proper allowance for the perfectly normal inaccuracies of the meter, and he is not allowing for the fact that, for a given meter, having a certain percentage accuracy, the actual numerical value of the possible inaccuracy in amperes, volts, etc., is larger the higher the range used. If he understood these things, he would expect to get different readings on each of the ranges.

DON'T TRY TO CHECK ONE METER AGAINST ANOTHER OF EQUAL ACCURACY

Another thing which Service Men (see Fig. 5B) often do is to check one meter against another having practically the same percentage accuracy (the ranges may either be the same, or different). Of course, when this is done, there may be a very wide difference between readings taken on similar quantities. If the ranges of the 2 instruments are different, of course it is practically certain that the readings of the 2 meters will differ materially. Even if the ranges are similar, it is likely that the readings will differ by varying amounts over the scale, for, the magnitudes of the inaccuracies in the instruments are not similar at the various points along the scale. For instance, if the error at the 2-V. point on the scale of one instrument is 0.1-V., there is no reason why exactly the same error should exist at the 2-V. point on the other instrument. It might be more—or less! The difference may be as much as 50 or 60% of the reading—especially if the reading is taken at the more-or-less inaccurate lower end of the scale. The percentage accuracy rating of an instrument does not tell one exactly what the error will be at each point on the scale—it tells us only that the error will not exceed a certain amount! Therefore, since both instruments have inaccuracies, one should not be compared with the other, or judged by the other!

Checking one instrument against another is only sensible when the instrument checked-against is known to have a much higher degree of accuracy than the one which is to be checked. That is the way instruments are calibrated at the factory—but a very accurate "standard" meter is used for the purpose!

ANOTHER INCORRECT CHECKING PRACTICE

Another Service Men's practice that leads to incorrect conclusions is that of checking the accuracy of their meters by performing voltage-

current-resistance tube-socket analyses on brand new standard-make receivers which they have just received from the factory. They then compare the readings they obtain on the meters with the values on the voltage-current-resistance charts supplied by the receiver manufacturer. (See Fig. 5C.) There are several reasons why this is a senseless method of checking the accuracy of a meter. They are:

(1) The line voltage may not be at the correct value specified for the receiver.

(2) Voltage, current, or resistance check-values supplied by receiver manufacturers for their sets are always specified with the understanding that a tolerance of at least ± 10% should be allowed. In many cases, this allowable tolerance is ± 20%! How can a Service Man logically expect to check a meter having an accuracy of say 2%, by comparing its readings with voltage, current, or resistance values which the receiver manufacturer himself expects may be off by as much as ± 20%? You supply the answer!

(3) When checking the voltage values, the meter readings may not correspond with the values specified by the receiver manufacturer simply because the resistance of the voltmeter range being used by the Service Man may not be the same as that which was employed by the set manufacturer during the initial tests. The Service Man's voltmeter may load the circuit more (or less) than the set manufacturer's voltmeter did—thereby changing both the current of the circuit, and the voltage reading.

PERMANENCY OF ACCURACY IS AN IMPORTANT CHARACTERISTIC

One important characteristic of electrical indicating instruments which does not seem to be given sufficient attention by Service Men, is the permanency of their accuracy. The specified degree of accuracy should be maintained over a period of years—assuming, of course, that the meter has not been abused by constant overloading, rough handling, etc. This means that good design and materials of good quality should be used in its construction. Since the purchaser cannot readily examine the interior parts of most commercial instruments when he buys them, he must be guided by the integrity and reliability of the manufacturer, and remember that as a rule, among the instruments of any given manufacturer, the more one pays for an instrument, the better the quality of materials used in it and the more permanent its accuracy is apt to be.

The design of the instrument should be such that permanence of adjustments is secured. The materials used must be suitable, and properly worked and assembled. For example, even the finest magnet steel obtainable will give poor results if the heat treatment is not suitable. These few points will serve to show upon what complex conditions the reliability of electrical instruments depends, and hence to what a large extent the integrity, experience, manufacturing, and test facilities, and shop system of the maker affect the reliability and permanence of the product.

IT IS ESSENTIAL TO USE EXTREME CARE IN HANDLING TEST INSTRUMENTS

Electrical instruments are essentially delicate; their operating forces are small, and their accuracy depends upon every part remaining in excellent condition—especially such parts as pivots and jewel bearings, springs, magnets, etc. They should therefore be handled carefully and not exposed to unnecessary vibration, moisture, extremes of temperature, mechanical shocks, etc.

The common practice of throwing test equipment in the back of a passenger car or servicing truck, and then (see Fig. 5D) driving over rough roads or bumpy railroad crossings at high speed, around sharp curves literally on 2 wheels, etc., is to be strongly advised against. Meters are not designed to withstand the severe jolting they get on such trips. Their silent way of protesting is by a let-down in accuracy over a period of time—if not immediate erratic operation, due to broken jewels, pivots, etc. If you get into the habit of treating your meters as you would a fine watch, they won't let you down.

INSTRUMENT REPAIR

What should be done when a meter becomes damaged so that it either does not operate at all, or else becomes so inaccurate that its read-

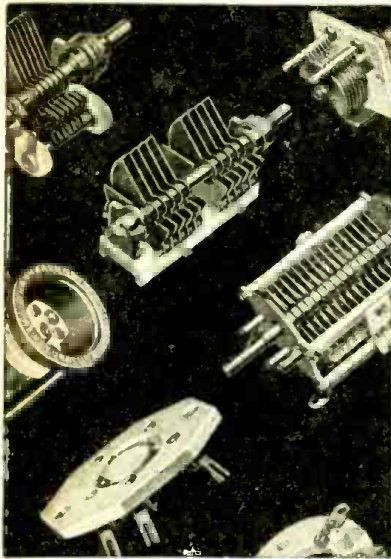

AGAIN THE SPECIAL CHOICE OF EXPERTS!

SINCE 1911, when Hammarlund products were first introduced, engineers, professionals, amateurs, set builders, and experimenters throughout the world have developed and constructed their receivers, transmitters and test equipment exclusively with Hammarlund products—products that insure dependable service for superior results!

Every Hammarlund product designed for peak electrical and mechanical efficiency uses finest quality insulation, carefully selected metals and assuring trouble-free long lasting service. Hammarlund, today, manufactures over 500 precision products such as—single and split-stator midget and micro variable condensers (available in 41 sizes, 20 to 320 mmf.); transmitting condensers (38 sizes, 20 to 1,000 mmf.—1,000 to 12,000 volts); acorn and standard Isolantite sockets (4 to 8 prongs); receiving and transmitting R.F. chokes (6 types—2.1 mh. to 250 mh.—60 ma. to 500 ma.); XP-53 plug-in coils (plain and wound—4, 5, and 6 prongs), etc.

If you want the best results, use Hammarlund products—they will never fail you! To be sure you get a genuine Hammarlund product, look for the name HAMMARLUND stamped on every product. The new Hammarlund catalog with complete details on all Hammarlund products is now ready. Mail the coupon for your free copy.

Mail Coupon Now!

HAMMARLUND MFG. CO., INC.
424-438 W. 33rd St., N. Y. City

Please send me the new HAMMARLUND catalog

Name

Address

City State RC-1-38



Please Say That You Saw It in RADIO-CRAFT

ings are no longer of value in your work? Relatively few users possess either the ability, experience, or facilities necessary for the repair and subsequent calibration of an electrical indicating instrument. Those Service Men who have tried to make major repairs on their own instruments will agree with me—for, the usual result of home repairing is the same as that which happens when 10-year-old "Junior" decides to take his shiny new Christmas pocket-watch apart!

First of all, do not send good dollars after bad pennies by repairing obsolete instruments, instead of replacing them with improved models at a cost which is often lower than that of repairs.

Second, ship your instrument back to the Repair Department of the manufacturer—or to his nearest Authorized Repair Station if you prefer. There are reliable instrument repair shops that carry authorized parts, employ experienced, high-class instrument men, and do excellent repair work. Make sure you deal with one of these—keep away from "monkeywrench and screw-driver" instrument repairers, who offer to do the job for less. You know what this type of radio repair man will do to a fine radio set—your servicing instruments are even more delicate! Don't take chances. Have your meters repaired by someone who really *knows how!*

HOW TO SHIP METERS FOR REPAIR

When you ship a meter to an authorized service station (or to the manufacturer) for repair, be sure to pack it carefully. Meters can be shipped by express with practically the same assurance of their safety as when they are carried by messengers, provided they are properly packed!

Always pack the meters in a box—either of heavy corrugated paper-board, or wood. The size of the box should be such as to allow from 4 to 6 ins. of clear packing space between the meter and the box on all sides. (See Fig. 5D.) This space should be closely packed with excelsior, shredded strips of newspaper, tissue paper, etc.

First wrap the meter in a piece of paper, then follow with a covering of corrugated paper-board. Then it is well to put on an outside wrapping of waterproof paper such as waxed paper, etc., securely tied. The bottom of the shipping box should first be filled with the excelsior, shredded paper, etc. (closely tamped), to such a depth that it will support the meter at the center of the box. The wrapped-up meter is then laid in place and covered with more excelsior or shredded paper, tightly packed until the box is full. This acts as a complete cushion all around the meter. The cover is then fastened on, the box tied securely with strong cord, and the meter is ready for shipment. Print your own name—as well as that of the party you are sending it to—on the box clearly.

WRITE A LETTER OF INSTRUCTIONS

Don't forget to communicate with the repair organization or manufacturer in a separately-mailed letter, regarding the meter, explaining what you want done, and authorizing them to make the repair. It is important that this letter of instruction and authorization be sent separately—not enclosed in the package with the meters.

Most instruments are sent by express, and it is a common occurrence for a Service Man to enclose a letter inside the package containing his instrument and then raise Cain because the repair department of the manufacturer will not accept the package since he has no previous correspondence or instructions concerning it. Most manufacturers will not accept instruments unless they have a separate communication advising them of the disposition required—repair—exchange—credit, etc. Here are the reasons! It is a violation of the inter-state commerce laws for a common carrier (like the express company) to allow a package to be opened until it is accepted. Manufacturers cannot make a practice of accepting any and all packages indiscriminately, because some persons would return instruments which were partly paid for under the time payment plans and say, in effect, "I don't want the instrument, I've returned it to you. You accepted it, so that breaks any contract that I might have previously made with you." By refusing shipment until disposition instructions are given, manufacturers side-track a great deal of potential trouble of this kind. So write your instructions and order for repair work in a separately-mailed letter at the time you ship the instruments!

They're all in the New FREE 1938 CATALOG

The Winter Edition of our New 44 page Radio Catalog is an Encyclopedia on Standard Radio sets. It lists all the well known makes in home electric sets—farm battery radios and auto radios; shows you all the newest 1938 models and gives you the features in each; such as Magic Voice with electric tuning in RCA-Victor; Robot dial, Acoustic adapter in Zenith; Inclined panel control for ease and grace in Philco; Touch tuning with 16 buttons in G.E.; Flash tuning, Acoustical Labyrinth in Stromberg Carlson; Teledial automatic tuning in Grunow; Transformerless AC circuit in Kadette; Quicktune dial in Crosley; and many other unusual features in these and other sets, too numerous to mention.

**SERVICEMEN AGENTS
RADIO SALESMEN**

with a marvelous catalog such as ours—it is very simple for you to earn \$100 or more weekly in commissions, by becoming a MODELL representative in your community. Our plan does not require any investment on your part. The many ways we assist you, will help materially in developing and building up a permanent business of your own. Experience is not necessary, as our instructions give you all the help and ideas you will need to stimulate business in your locality. Men and women in cities, hamlets, farms, have found the MODELL plan so simple and effective, their letters of praise are pouring in daily.

EASY PAY PLAN

We have just added a new feature in our sales department. **THE EASY PAY PLAN**—by mail. You now can obtain any radio set for as little as \$5 down and the balance for as low as 50¢ weekly. You may take up to 20 months to pay.

Territory is now being allotted to full or spare time men. If you want an honest to goodness proposition, that will give you honest dollars, RUSH the coupon below for details and our big new Winter Edition of our 44 page 1938 radio catalog.

3 Year written guarantee goes with each radio set

30 days free trial

Modell's

Since 1889 DEPT. D-8
NEW YORK, N. Y.
58 Cortlandt St.
CHICAGO, ILL.
56 W. Washington St.
ATLANTA, GA.
57 Forsyth St.



1938 EMERSON

1938 ZENITH

1938 PHILCO

1938 MOTOROLA

1938 CROSLEY

1938 RCA VICTOR

1938 DELCO

1938 GENERAL ELECTRIC

1938 KADETTE

1938 GRUNOW

and over
400
other models

**MAIL COUPON
TODAY**

MODELL'S—Agency Division, Dept. D-8
58 Cortlandt St., New York, N. Y.

Gentlemen:
RUSH me FREE your winter edition, 44 page New 1938 Radio Catalog, also your EASY PAY PLAN and agents' proposition.

NAME

ADDRESS

CITY STATE

Paste coupon on 1c postcard.

• WITH RACO SHORT-WAVE KITS YOU CAN ALWAYS BUILD BETTER RECEIVERS •

RACO CRASHES THROUGH WITH NEW S-W VALUES

You fans who want real DX must have a RACO SHORT-WAVE RECEIVER. Any one of the many RACO sets pulls in stations from far corners of the globe.

UNIVERSAL CLIPPER

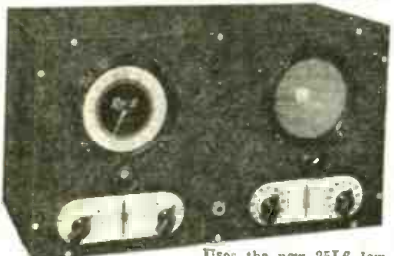

Uses the new 25L6 low voltage beam power tube which makes possible high power output with an inexpensive A.C.-D.C. power supply, operating from any type of 110-volt current. Here is the famous CLIPPER circuit. The same smooth, non-critical tuning; combined regeneration and super-regeneration; separate bandspread and ultra-high frequency tuning condenser; 5 inch dynamic speaker; 3 to 555 meter tuning range; automatic earphone jack; in fact, all of the splendid features which make the CLIPPER circuit a tremendous success.

ASK THE MAN WHO OWNS A CLIPPER—LOOK AT HIS LOG!

COMPLETE KIT WITH ALL PARTS ASSEMBLED and wiring diagram; less only tubes and cabinet, unwired

Black crackle finish cabinet 1.80
Matched set of five tubes 3.20
Wiring 2.90

UNIVERSAL CLIPPER—COMPLETE, with black crackle cabinet (20" x 10" x 9"); five tubes; 6K7, 2-6J5G, 25L6, 25Z6G; ready to operate, and one-year guarantee
Special Complete Price \$19.50

THE NEW RANGER

3-TUBE UNIVERSAL A.C.-D.C.



AMAZING VALUE IN THIS SPLEN-DID ALL-WAVE SET! You will be astounded at the way it brings foreigners rolling in. Yes, and separates them, too! Uses supersensitive electron coupled regenerative circuit giving smooth tuning and perfect regeneration control over its entire wave-length range. Tunes from 15 to 550 meters with positively no skips.

RANGER 3-TUBE UNIVERSAL A.C.-D.C.—complete kit, assembled but not wired, including wiring diagram and broadcast coil but less cabinet and tubes

3 additional metal cabinets 90
Crystallized coils (15 to 200 meters) 60
Set of three tubes (2-6J5G; 1-6A7) 1.35
Wired and tested 1.40

SPECIAL COMPLETE PRICE with all coils, cabinet and tubes, wired and tested, with one-year guarantee 8.25

FREE Catalog!

Kits, receivers, converters, antenna information—everything you'd expect to find in a complete short-wave catalog—at prices astoundingly low. Write today for RACO'S LATEST SHORT-WAVE CATALOG—illustrating and technically describing RACO'S complete line of long distance receivers.
ADDRESS DEPT. RC-138

RADIO CONSTRUCTORS LABORATORIES
136 LIBERTY ST., NEW YORK, N.Y.

"LEARN-BY-EXPERIMENTING" BEGINNERS' PRACTICAL RADIO COURSE

SIMPLE WAVEMETER AND SIGNAL GENERATOR

(Continued from page 411)

Although every radio set is thus, in effect, a wavemeter, many factors make it unsatisfactory for use as such. These factors are (1) the presence of the antenna; (2) the usual multiplicity of tubes, variable condensers and fixed condensers (known as *padders*); and also, (3) the dependence of the set on a broadcasting signal which, though very constant in frequency, is continually changing in sound volume as the voice or music comes over the air.

The requirements of a satisfactory wavemeter are met by the use of a single coil and condenser combination (LC); by a short, constant length of wire for an antenna (ANT.), and by incorporating a generator which will give a signal that is constant, both in the frequency and in the volume of the signal that it generates, such as the buzzer generator employed here (B). This type of generator produces a radio wave by the action of the successive sparks which are formed at the contact point of the vibrating armature of the buzzer. These sparks radiate radio-frequency waves just as did the early radio spark-coil transmitters. (Note that this method of obtaining a constant signal is different from that used in the *Service Man's signal generator*, where a radio tube is generally employed in an *oscillating circuit* to produce the radio-frequency waves.)

Another desirable requirement of a good wavemeter is that it should efficiently cover a *wide range of frequencies*. This is accomplished here in the simplest possible manner by an arrangement for changing the coils by a plug-in system. In this way, we use only 1 variable condenser with 1 coil to cover a certain band (that is a certain range of frequencies), and then use the same variable condenser with another coil to obtain coverage of another wave band. In conjunction with a variable condenser having a standard capacity of 0.00014-microfarad (mf.), or 140 micro-microfarads (mmf.), which is the same thing, the coils selected for use here will cover practically all the frequency ranges on which broadcast and short-wave signals are sent. The 5 coils (lettered so that the coil having the greatest number of turns is called A) cover the following ranges:

- Coil A covers *Broadcast Band*: 535-1,200 kc. (or 560-250 meters);
- Coil B covers *Short-Wave Band*: 1,100-2,200 kc. (or 270-135 m.);
- Coil C covers *Short-Wave Band*: 2,000-4,500 kc. (or 150-66 m.);
- Coil D covers *Short-Wave Band*: 4,000-9,100 kc. (or 75-33 m.);
- Coil E covers *Short-Wave Band*: 7,300-17,000 kc. (or 41-17 m.).

CALIBRATING THE COILS

Instructions for calibrating a coil over its entire range are given in the Experiment, and a sample tuning (*calibration*) curve for coil A is shown in Fig. 2. For those who wish the wavemeter to have tuning curves for all these bands, it will be advantageous to use the particular combination of condenser and coils as specified here, since *calibration curves* for these bands are available for this combination. If, however, only a *tuning curve* for the broadcast band is desired, this precaution does not matter, and it will be found to be a relatively simple matter to follow the instructions for making a tuning curve for this band with any coil and condenser combination. The broadcast coil is much easier to calibrate than the other coils because it is possible to use broadcast stations of known fre-

quencies as "marker" or "spotting" points for the tuning curve.

The additional circuit for converting the tuning unit of the wavemeter into a Crystal-type Radio Receiving Set is included here because it is a good way—from the standpoint of simplicity—to illustrate the employment of resonance in a radio receiver. However it must be kept in mind that, from the standpoint of performance, no more than barely audible reception is to be expected from the crystal set. For this reason, the discussion of the principles involved in the operation of a radio receiver will be left for a later Experiment, when the far-superior vacuum-tube type of receiver will be discussed.

PROCEDURE AND RESULTS

(Part A) Construction and Calibration of Wavemeter

CONSTRUCTION

The mounting of the parts is shown in the photographs, Figs. A and B. The variable condenser is mounted under the aluminum subpanel which also acts as a dust cover. This subpanel has 2 socket holes punched in it, one for the plug-in coil socket, S, and one for the buzzer, B. The binding posts for the buzzer are insulated from the metal by insulating washers.

In making the connections shown in Fig. 3A, note that the lug terminal for the moving plates (the rotor) of the variable condenser goes to the metal chassis connection, as do the number 1 and 4 terminals of the coil socket. This is necessary to reduce the effect of the hand when tuning (*body-capacity effect*). The wires connecting the buzzer (B), battery (Batt.), and tuning unit (LC) should be reasonably short. Note that (when connecting the wavemeter to the receiver to be tested) the insulated wire going to the antenna post of the receiver does not make direct electrical contact with binding post terminal 2 of the coil socket, but is coupled (called *capacity coupling*) to the post by twisting the wire, insulation and all, 3 or 4 times around another short insulated wire (about 2 or 3 ins. long), which is connected to terminal 2. Terminal 1, which is ordinarily a ground connection, is left "floating" (unused) when this type of buzzer generator is used. See Fig. 5.

OPERATION

Using any type of broadcast receiver, tune in a station about midway on its dial. Without disturbing the tuning, connect (by means of a capacity connection as mentioned above) the wire from the wavemeter to the antenna post of the receiver in place of the regular antenna. Plug-in a coil (Broadcast coil A, marked 250-560 m.) in the wavemeter socket whereupon the buzzer starts vibrating. (Note: Because of the large number of turns on this coil, it will most likely be necessary to start the buzzer manually, by gently plucking the armature.) With the buzzer working, rotate the wavemeter dial until the buzz is heard most loudly in the loudspeaker of the receiver. Note the setting of the wavemeter dial at which this occurs, and enter the result in a table of 2 columns, as shown in the example below.

Repeat this operation to obtain about 6 other points (preferably 3 on each side of the middle of the wavemeter dial).

Plot these 7 points on graph paper and draw a tuning curve similar to the sample curve given in Fig. 2. This graph is now a *calibration chart* of that particular coil.

PRELIMINARY CALIBRATION CHART

(The data from this chart is then plotted on graph paper, which thereupon becomes the final calibration chart as shown in Fig. 2.)

Wavemeter Dial Reading	Example					
	27					
Frequency in kc.	860 kc. (WABC)					

Please Say That You Saw It in RADIO-CRAFT

Note! This operation may be speeded up considerably if it is found possible to leave the regular antenna connected to the receiver, and still hear the buzzer in the receiver when the wire from the wavemeter is loosely wound around the insulation of the regular antenna wire.

(Part B) Determining the Frequency to which a Receiver is Tuned

With the receiver in operation, and the wire from the wavemeter placed as before, set the wavemeter dial to some desired frequency, such as 1,400 kc., obtaining this point from the calibrated tuning curve made in Part A. Now tune the receiver until the buzz is received at a maximum. At this setting, the receiver is tuned to the desired frequency.

(Part C) Added Circuit for Crystal Receiver

Mount the strip containing the crystal detector as shown in photo, Fig. A, and make connections to it, shown in Fig. 3B. Connect a good antenna to binding post 2 and a good ground to binding post 1. The crystal detector must be adjusted to a sensitive point. This is best done by setting the tuning dial to the frequency of a powerful local station and "playing" with the crystal adjustment (the "cat-whisker" of former fame), until the station is heard in the phones. The number of stations that can be received on this crystal-type radio set will depend quite largely on this adjustment and on the number of powerful stations in the local vicinity. The dotted lines in Fig. 4 (page 411) are the connections to be added to those of the wavemeter (shown in heavy lines). Connections marked "X" are to be opened.

CONCLUSION

A circuit is said to be in resonance with another circuit, when one is tuned to the same frequency as the other. Since the frequency to which a circuit is tuned depends upon the amount of inductance of the coil and the amount of capacity of the condenser in the circuit, the condition of resonance may be obtained by varying the capacity of the condenser until the combination is tuned to this desired frequency.

****QUESTIONS**

- (1) A wavemeter measures: (the strength of a radio wave; the distance a radio wave can travel; the frequency of a radio wave).
- (2) A high-frequency radio station is classed as: (a long-wave station; a short-wave station; a broadcast-wave station).
- (3) A Wave Generator (or Signal Generator), of the type here described, sends out: (an audio-frequency wave; a radio-frequency wave).
- (4) Tuning the wavemeter to resonance is accomplished: (by varying the capacity of a condenser; by varying the inductance of a coil; by varying the resistance of a resistor).
- (5) A frequency of 1,500,000 cycles is the same as: (1,500 meters; 1,500 megacycles; 1,500 kilocycles).

*Answers to questions appear on page 427. Radio Clubs and School Groups are invited to write to the editors concerning the use of the material of these Experiments in quantities for school use.

LIST OF PARTS

- One plug-in coil, 4-prong, broadcast band, Hammarlund type BCC-4, L1, L2;
 (Optional) Set of 4 short-wave plug-in coils, 4 prong, Hammarlund type SWK-4 (optional calibration curves are available);
 One variable condenser, 0.00014-mf. (or 140 mmf.), Hammarlund type SM-140;
 *One dial, 2 3/4 ins., type 713;
 *One buzzer, high-frequency;
 *†One socket, 4-prong, subpanel mount;
 †One front panel, bakelite, 4 1/4 by 5 1/2 by 1/8-in. thick;
 *One subpanel, aluminum, punched;
 †Six binding posts;
 †One National Carbon Co. dry battery, "C" type, 4 1/2 V.;
 One broadcast receiver (of any type).
Added Parts for Crystal Receiver
 *One crystal detector, galena;
 *†One pair headphones;
 One mounting strip, bakelite, 4 1/4 by 1 1/2 by 1/8-in. thick;
 Four binding posts.
 *Most Radio mail order houses can supply this item if properly identified as to title of article, issue (month) of *Radio-Craft* and year.
 †Indicates part used in previous experiments of series.

NEW OPPORTUNITIES for a BIGGER and BETTER SERVICE BUSINESS

NATIONAL UNION RADIO TUBES—

- A Complete Line
- Highest Quality
- Thoroughly Guaranteed



NATIONAL UNION CONDENSERS—

- A Complete Line of Electrolytics and Papers



...PLUS FREE EQUIPMENT

Now National Union deals can be worked out with both N.U. Radio Tubes and N.U. Condensers. This is wonderful news for the service engineer who wants more and better equipment. Your condenser purchases combined with your tube purchases makes it easier and quicker to own the kind of equipment you want.

National Union has constantly put the latest advances in scientific equipment as well as modern selling aids within reach of the service dealer.

The National Union deal calls for a dealer deposit which is rebated when the purchase of the required amount of tubes and condensers has been made. Thousands of completed deals. Every dealer should investigate. Just ask your jobber.

THE ROAD TO BETTER BUSINESS

1. Full guarantee on highest quality radio tubes.
2. Cut price business not solicited.
3. Price Protection.
4. N. U. jobber stocks are complete...No hunting for odd types.
5. Timely business building aids.

National Union Radio Corporation, RC-138
 570 Lexington Avenue, New York City.

—I am interested in obtaining complete information on your proposition.

Name

Address

City State



HUM Is Expected

HUM is expected around bee hives but should not be tolerated in audio design. Kenyon Hum Bucking Transformers are priced as low as \$2.40.

Catalogs describing the various Kenyon audio and power components obtainable from your local dealer.

KENYON TRANSFORMER CO., Inc.
 840 BARRY STREET NEW YORK, N. Y.

THOUSANDS HAVE SELECTED THIS TUBE TESTER

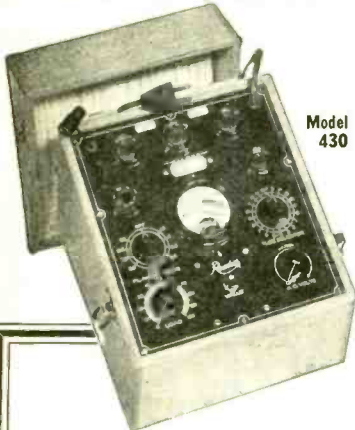

Only \$19.80

Positively Checks All Type Radio Tubes According to Latest Recommendation of Tube Engineers

- Has Line Voltage Adjustment
- Has Leakage and Short Test
- Uses Triplett Direct Reading Instrument (GOOD-BAD) Scale

Five flush type sockets provide for all tubes. The tester operation is very simple and indicates condition of the tube for dealer and customer on Direct Reading (GOOD-BAD) colored scale of Triplett instrument. Will also test for interelement shorts and leakages. Complete in attractive, sturdy, quartered-oak case. Sloping etched panel of silver and black. Suitable for portable and counter use.

Dealer Price \$19.80

Model 431 same as 430, except has Readrite (GOOD-BAD) Meter.

Dealer Price \$15.90

A MODIFIED EMISSION-TYPE TESTER...APPROVED CIRCUIT

See Your Jobber — Write for Catalog



READRITE METER WORKS
116 College Ave., Bluffton, Ohio

— Please send me more complete information on Model 430;
— Model 431.

Name

Address

City

State

SHORT-WAVE RADIO MARCHES ON!

(Continued from page 393)

731-Line (and Perhaps 1,200-Line) Television Transmission. This amazing bit of information aired by Mr. Urtel comes as a surprise, considering the fact that at present we content ourselves with experiments, here in the U.S., with 441 lines only. However, a German subsidiary of Farnsworth (The Fernseh, A.G., of Berlin) has let the cat out of the bag, and demonstrated at the recent Berlin Radio Show 731-line television transmission.

But this is not all. Informed observers of public taste doubt very much that even 731-line television performance will have sufficient entertainment value for the public. The main argument of these experts is this undeniable fact: the public is spoiled by the very highly developed technique of movie presentation. Some of the very ardent critics of television even go so far as to predict that 1,200 lines will be required to do the trick. (An efficiency of only 16% is an accepted value for 441-line television, as shown in Fig. 3, "The Balance Sheet of Television," pg. 81, August, 1937, *Radio-Craft*.—Editor)

Channels of Giant Bandwidth Required. All these calculations sound very wonderful when propounded by "know-nothing" but "discuss-everything" critics. But let's look at the facts. Present 441-line television transmission requires a bandwidth of 3,250 kc. which is (in order to give a comparison) as large as the bandwidth covered by 650 broadcast stations (see *Radio-Craft*, August, 1937, pg. 80).

Now, in order to transmit the video impulses of a 731-line television transmission there will be required a bandwidth approximately equal to the bandwidths of all broadcasting transmitters now operating throughout the globe! Transmission channels of such a gigantic bandwidth can be provided only in the microwave region, or short radio waves of about 1 meter and below.

Having determined that microwaves afford all the bandwidth we could possibly want for multiple program transmissions, and for television programs having fidelity far surpassing even the finest laboratory products today demonstrable, let us now turn to the tube designers and see what they are doing to give us the requisite power at even the decimeter wavelengths.

HIGH-POWER MICROWAVE TUBES

Transmitter designers were unable until this year to provide us with equipment capable of radiating more than the customary 10-25 watts in the range of the decimeter waves. This information seems surprising after all the nice things which have been said about the capability of the magnetron as a generator of extremely short radio waves.

But tube design has made tremendous strides in the past few years, and a new tube developed by Mr. Winfield G. Wagener of the RCA Lab-

oratories which is able to generate 700 W. at 100 megacycles, indicates a new trend in transmitter design for decimeter-wave generation. The new tube, almost of fountain-pen size, is shown in Fig. A.

This tube delivers high power output despite its closely-spaced tiny grid and water-jacket anode. (See *Radio-Craft*, Aug. 1937, pg. 78.—Editor) The new tube operates with a plate voltage of 3,000 V. Indications are, that a great many tubes of similar type (of symmetrical design) will appear in the next few years; and 700 W. at 100 megacycles is just the beginning. Even 50 kw. at 33 megacycles is about a borderline—just to give an idea about future possibilities!

Still, we are not through telling you about the good things the year 1937 dropped into the lap of the high-frequency specialist. Having seen that wavelengths may be "sliced" into many "lanes," and that high-power microwave tubes are now available, let us now see what the antenna specialists accomplished during 1937 in adding further economy and efficiency to operation in the higher-frequency brackets.

STEERABLE SHORT-WAVE ANTENNA COMPENSATES FADING

One of the most amazing developments in the field of short-wave reception is a new trick antenna designed by H. T. Friis and C. B. Feldman of the Bell Telephone Laboratories. We have known for a long time: the more or less directional effect of the customary short-wave antenna is the indirect cause of fading (as perceived at the receiver). The actual reason is of course the steadily varying angle of reflection at which short waves approach the antenna of the receiving station.

Since we have no means to force the short waves to arrive at a uniform angle the Bell engineers decided to try the next best thing, namely, a system of adjustable antennas. The first installation of this type is now in operation at the transatlantic receiving station at Holmdel, N. J. See Fig. 2D.

Those of us who have visited a commercial station will probably recall that the antennas used are often of considerable length. The new antenna system used at Holmdel consists of 6 separate antenna units, and has a total length of $\frac{3}{4}$ -mile; this of course precludes even the mere thought of moving such giants in order to adjust them to the steadily varying angle at which short waves arrive.

How the Trick is Accomplished. Nevertheless, the Bell people have accomplished the trick! Instead of adjusting the "pick-up angle" (azimuthal directivity) of the antennas (which, for the reasons mentioned above, is impossible) they use an ingenious system of "antenna-tappers," by which they obtain access to the antenna output

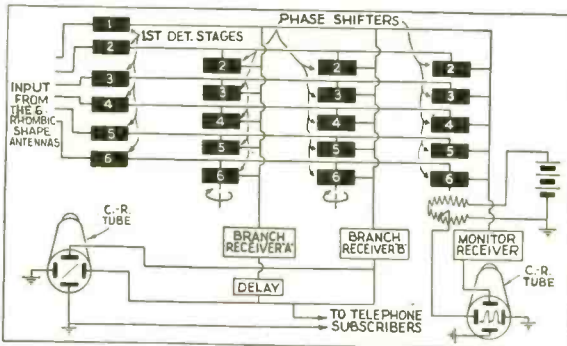
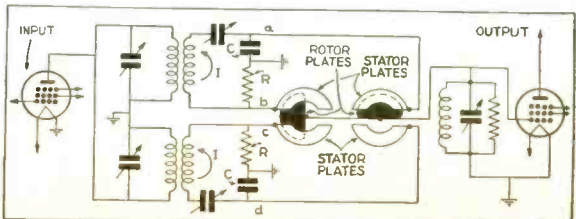

Fig. 3. Block diagram of the experimental MUSA receiver. One group of the phase shifters (extreme right) continuously explore for angle of arriving wave; the two others, set accordingly, feed their outputs to conventional radio receivers with common gain control. A cathode-ray tube displays output waveform of either phasing group.

Fig. 4. Of numerous phase-shifting methods this one is chosen for the 18 circuits (3 branches, 6 antennas) of the MUSA system. Voltages of opposite phase connect to adjacent stators of a special variable condenser; the quadrature rotors, ganged, mount as shown.



Please Say That You Saw It in RADIO-CRAFT

voltages of all 6 antennas. The output of all antennas is mixed into 1 channel (see Fig. 3), but since each of the 6 voltages has a different phase it is necessary to synchronize their phases before mixing them. This is accomplished by means of rotating phase-shifters.

It all sounds very simple, when described in this breezy manner, but now let's look at the block diagram, Fig. 4! You see?—there is no chance, at least at present, of applying this wonderful antifading remedy to any but commercial receiving stations. (Bell engineers call this the MUSA or "Multiple-Unit Steerable Antenna" system.—Editor)

Closely linked to the subject of antennas is that of feeders, and now, let us see how a problem in this field (but not related to the previously-discussed problems of commercial transatlantic stations) was solved, in 1937.

Pipeline Used as Ultra-Shortwave Feeder. The General Electric Co., which during the last few years has installed a great many communications systems for police headquarters, was recently confronted with a problem for which no satisfactory solution was known so far. Because of the restricted space at one middle-Western police headquarters the transmitting as well as the receiving system for simultaneous duplex operation had to be operated from one and the same antenna, and this without any interference between transmitter and receiver.

Considering the fact that the output power of the transmitter was 150 W. (frequency range 30-42 megacycles), one can easily understand the headache of the G.E. engineers, who tried to solve the problem by means of conventional filter circuits consisting of coils and condensers. Finally Mr. L. M. Leeds of the G.E. Research Laboratories found a way which is worthy to be listed among the most interesting design tricks applied in the last few years in short-wave communication.

Instead of using a filter circuit of customary design he connected the antenna with the transmitter, and respectively with the receiver, by means of a concentric transmission line. This line, however—unlike previous concentric types—was so dimensioned as to operate as a narrow-band or peak-elimination filter.

The ultimate trick which made this filter effect possible was the utilization of an electrical phenomenon known to engineers by the name of "standing waves" on concentric transmission lines. The new filter is so effective and simple, that its general application will probably become as common as the use of radio tubes is today.

And so with these few remarks we close our resume of short-wave activities during 1937. Space limitations made it necessary to discuss only a few of the more outstanding developments; and none of the many, less spectacular (but perhaps equally as important) ones.

ANSWERS TO QUESTIONS ON PAGE 425—EXPERIMENT NO. 4

- (1) A wavemeter measures the frequency of a radio wave.
- (2) A high-frequency radio station is classed as a short-wave station.
- (3) A Wave Generator sends out a radio-frequency wave.
- (4) Tuning the wavemeter to resonance is accomplished by varying the capacity of a condenser.
- (5) A frequency of 1,500,000 cycles is 1,500 kilocycles.

NEW "CONTACT MIKE" USE



AT THE Radio Parts Show in New York, recently, it was shown that an entire orchestra could probably be arranged to play even in a boiler factory without the audience hearing anything but the music! One instrument, the ukelele, used in test is shown at left; its Amperite contact microphone (arrow), and sound system (not shown) did the trick.

ALLIED

Presents
RADIO'S NEWEST FEATURES
AT LOWEST PRICES!
in 61 New Knight Radios

ALLIED leads again in value with 61 new Knight Radios combining radio's newest features at the season's lowest prices! Advanced R.C.A. and Hazeltine licensed circuits, with Electric Push-Button Tuning—a station a second, Select-O-Matic Dials, the Electric Eye, Automatic Frequency Control, Full Voice Speakers—broadcast Studio tone quality, world-wide range—all these features and many others at prices that challenge the industry. From 5 to 16-tube models—for AC, AC-DC, 6-volt, 32-volt, battery and auto operation. ALLIED'S volume and low distribution costs make Knight radio's greatest values, offering biggest profits for you. See all models in ALLIED'S great 1938 Catalog—

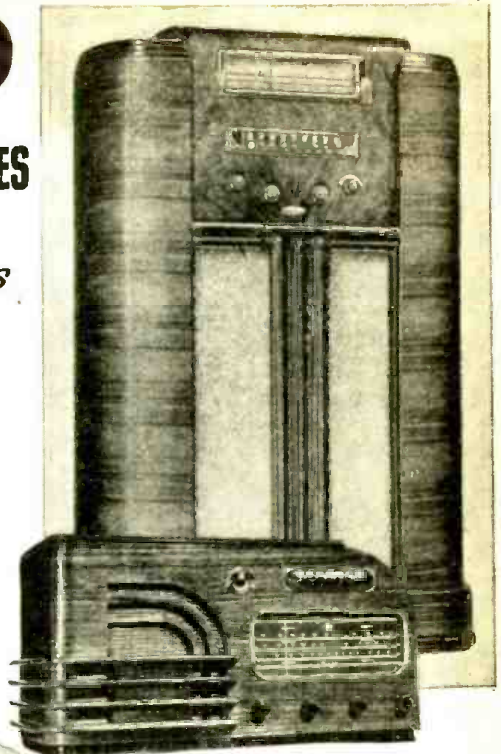

Just touch a button—
THERE'S YOUR STATION!

KNIGHT 11-TUBE
Push-Button Tuning
All-wave. Only **\$58⁹⁵**

KNIGHT 6-TUBE
Push-Button Tuning
3 Bands. ONLY ... **\$28⁸⁵**

KITS
P. A.
TESTERS

ALLIED'S Catalog offers over 12,000 parts—Builder's Kits (Write for free Parts Lists)—Sound Systems, Amateur gear, Test Equipment,—all at lowest prices.

EVERYTHING IN RADIO AT LOWEST PRICES!

Whether you're a Dealer, Service Man, Sound Specialist or Amateur-Experimenter, you need ALLIED'S 1938 Catalog. It brings you everything you need in one great book—Parts, Kits, Sound, Amateur, Test Equipment, books, tools, tool-kits—every radio requirement spread before your eyes. ALLIED'S complete stocks and fast service save you time—ALLIED'S low prices save you money. Send coupon today for free copy of ALLIED'S 1938 Catalog—radio's complete supply guide!

FREE Catalog

ALLIED RADIO CORP.
Dept. 2-A8, 833 W. Jackson Blvd.
Chicago, Ill.

- Send your Free 1938 Catalog
- Send Free Parts Lists for.....

Name

Address

City

State

ALLIED RADIO CORP.
833 W. JACKSON BLVD., CHICAGO

?

It will be the talk of the radio industry . . . it will keep you awake night after night . . . you'll probably go without breakfast, too . . . you'll miss a good movie or two . . . your best friend won't see you . . . **IT WILL BE THE GREATEST ACHIEVEMENT IN RADIO MAGAZINE HISTORY.** Tell your newsdealer to reserve a copy of **March, 1938, RADIO-CRAFT** for you.

Give Helpful Books for Xmas!
RADIO-ELECTRICITY
Books At Sensationally LOW PRICES

LATEST technical information by nationally known authorities. New popular size books. Crystal-clear explanations. Profusely illustrated. Most outstanding book values in America!

How To Build Exp. Lab. Work Bench . . . 20c
Exper. With 110-V. Electrical Arcs 23c
Motor Transformer Experiments . . . 25c
Radio Experimental Manual . . . 30c
Electrical Experiment Manual . . . 35c
Starting An Electric Repair Shop 35c
Electrical—Radio Dictionary, condensed electrical education. Newest, most complete at the price. Explains 676 terms. 217 ill. . . . 48c
Fault Location, Adjustment and Alignment of Radios. Equips you to service your own or for others 68c
Characteristics and Trouble Analysis of Radio Apparatus. Every radio-man and technician needs this book 75c
Radio Servicing Instructions, Circuits, data, operating instructions, etc. Two volumes, 222 ill. Both for . . . 98c
Short Course in Mathematics. Two vol. fractions to logarithms, clear, complete. Both for . . . \$3.05
Short Course in Electricity and Radio. Two vol. 332 illa. Newest, most complete. Both for . . . \$1.45
Complete Radio-Electrical Library, all 15 books. Free Xmas gift, postpaid, only . . . \$3.98

MAILED POSTPAID!
Send cash, check or stamps. Or books mailed C. O. D. ORDER NOW or send card for Free Folder describing full line of Low Priced Books!

20¢ TO YOU!

ELECTRONIC PUB. CO., Box 323-R, Lincoln, Nebr.

Please Say That You Saw It in RADIO-CRAFT

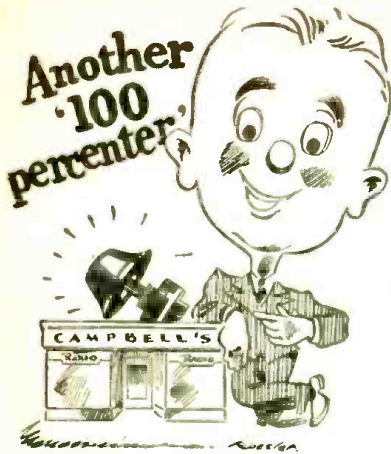

Mr. J. A. CAMPBELL
of Scranton, Pa., says:

... we consider QUALITY of parts a major essential ... and am consistently 100% Centralab.

Boy! ... what a boost for Old Man Centralab. But, then ... that's the reward for trying to "make a better mouse-trap than our neighbor." No wonder the radiomen have been making a beaten path to our door.

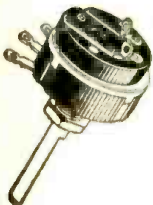

Get the 1937 Volume
Control Guide

Centralab

MILWAUKEE WISCONSIN

BRITISH CENTRALAB, LTD.
Canterbury Rd., Kilburn
London N.W. 6, England

FRENCH CENTRALAB CO.
118 Avenue Ledru-Rollin Paris XI, France

Save Money
on everything
you buy ...



**The New
BARGAIN
BULLETIN**

Your Guide to
Hundreds of Out-
standing Values.

FREE Write today for this outstanding new BARGAIN BULLETIN—there is no obligation on your part. High quality merchandise at sensationally low prices! Radio Sets, Parts, Sporting Goods, Watches, Clocks, Typewriters, Cameras, Novelties and many other items at real savings to you. Fair Dealing—Prompt and Courteous Service, always. Send for your Free BARGAIN BULLETIN now, try us, and be convinced of our superior values and service.

RADIO CIRCULAR CO., INC.
DEPARTMENT RC
315 Broadway New York, N. Y.

"SNOW STATIC" BEING BEATEN BY "FLYING LABORATORY"

(Continued from page 413)

There are two solutions open: (1) reduce the ability of the plane to gather or generate charges; and (2), admit that the plane cannot be prevented from gathering charges and work out a means for discharging it which will not cause radio interference.

The second solution offered the best possibilities although several plans for accomplishing the first will shortly be tested. It is probable that a partial solution of both will eventually be used.

SUPPRESSOR RESISTORS HELP REDUCE STATIC EFFECTS

A study of the noise indicates that it has a very short wavelength and that its attenuation with distance is rapid. The field pattern caused by a point in the corona at the rear of the airplane is shown in Fig. 1. Note how the area of interference production is continuous with the trailing edges of the airplane. When a resistor was added in series with the point the interference was materially reduced by a change in the noise field pattern to a location in the rear of the airplane and comparatively isolated from it, as illustrated in the lower portion of the diagram. Curves run on resistors indicate that at least 100,000 ohms and in some cases up to 10 megohms are necessary. Moving the point away from the plane takes advantage of the rapid attenuation and gives a better pattern.

This indicated that a trailing discharging point as far as possible behind the plane with suitable suppressor resistors had possibilities for discharging the plane. Up to 1 milliampere discharge at 50 ft. could be obtained with 100,000 V. without disturbance in the radio set using the regular antenna. A 25 microampere discharge from a point without suppressors 2 ft. from the plane prevented radio reception!

Since the mechanical troubles of a trailing wire are not desirable a second version of this idea was tried. Here a series of 17 3-ft., 3/1,000-in. dia. wires having a 5-megohm resistor in each was attached to suitable points on the wing and tail surfaces. Test flights of these dischargers are still in progress. Results in the air have verified the test made on the ground. The single trailing wire appears superior to the individual short wires though tests are not yet conclusive. The dischargers are still considerably short of a commercial cure and to date will only clear up radio range reception in about 15 per cent of the conditions encountered. Apparently the rate of discharge is not yet fast enough when the plane enters areas where the water particles have too high a potential. Although this system is not yet commercially practical, we feel that it is the first step on the road to a final solution.

ANTI-STATIC AIRCRAFT ANTENNAS

Our antenna tests indicate that snow-static interference is considerably worse at the rear than at the front of a plane. When the snow-static noise was of average strength, the loop located in the rear drop housing and the loop on the belly were both rotated and indicated that the source of maximum disturbance was toward the rear of the plane. When the static became extreme, rotating the loops indicated static in all directions. Probably corona had started on the wing tips and propellers in conditions of severe static.

In mild snow-static when beacon reception on the "V" antenna was normal, the 2 rear beacon antennas were so noisy that no beacon reception was possible. The vertical rear antenna had a 25 to 1 better signal pick-up due to polarization of the range signals, but the snow-static pick-up was about the same on either. Both rear beacon antennas were about the same length and spacing from the fuselage. We concluded that the snow-static interference radiation was not normally polarized.

Although the 10 ft. top antenna was far superior to the lower "V" antenna, from a signal pick-up standpoint, in snow-static the "V" antenna would pick up 5,000 kc. short-wave stations 1,000 miles away when they were unreadable on the top antenna.

Although we did not test a trailing wire as an antenna, we did conclude from our study that it should be about the worst form of antenna for reception in snow-static. It would carry as high as 2 milliamperes of discharge current in

vigorous "warm front" conditions. The static leak connected across the input of the average receiver is about 1/2-megohm; with a 2 ma. peak current the voltage drop across the antenna input circuit of the receiver could be 1,000 V. The noise modulation on this D.C. voltage would be less than 1%, or only a few volts of random A.C.

During the tests we reeled out 150 ft. of steel No. 14 B. & S. stranded aircraft cable. It had no resistance suppressors in it and did not increase or decrease snow-static on the beacon frequencies. The short-wave receiver, however, was tuned to a 60 meter wavelength, hence, the 150 ft. cable plus the 66 ft. plane length was more than one wavelength long. Reeling the cable in and out gave 2 nodes of maximum snow-static and 2 nodes of minimum snow-static. The minimum, however, was not sufficiently low to materially aid reception.

INSULATED ANTENNAS

At the time we began our tests there were some snow-static theories which presumed that the noise was due to charged particles striking the antenna. To check this, a special pair of rod antennas were constructed. These were hollow, 1 in. dia. tubes of bakelite and the other of aluminum. The single wire antenna was held in the center of these tubes by insulating discs and the lead-in completely enclosed in metal tubing. With this arrangement no particle of any kind could strike the antenna itself. The aluminum tube was grounded to the plane at 3 points with 1/10-meg. resistors. The bakelite tube was painted with a solution of airplane dope and graphite so that its entire surface was a 10,000-ohm resistance leak to the plane. Good beacon reception was obtained on either antenna, but they gave no advantage over the regular No. 14 bare copper wire antenna exposed to the snow and rain particles. We concluded that the impinging particles were not sources of noise, or that the corona noise was so great that the impinging particle noise was obscured.

In conditions when the plane is highly charged and corona appears as St. Elmos' Fire at the propeller tips, the regular bare No. 14 antenna wires must also go into corona. Since the wires have a small diameter they might discharge to the atmosphere sooner than other points on the plane. To test this, the "V" beacon antenna was replaced with wires having a diameter from 3/1,000-in. up to 1 in. dia. tubing. As the diameter increased, the reception improved and the outgoing corona current decreased. The curves indicate, however, that only a very small advantage would be gained by increasing the present wire diameter from No. 14 to No. 10.

It is of material importance to reduce all sharp points such as cotter keys on antenna fittings, and to generally round off all rough edges on antenna structures.

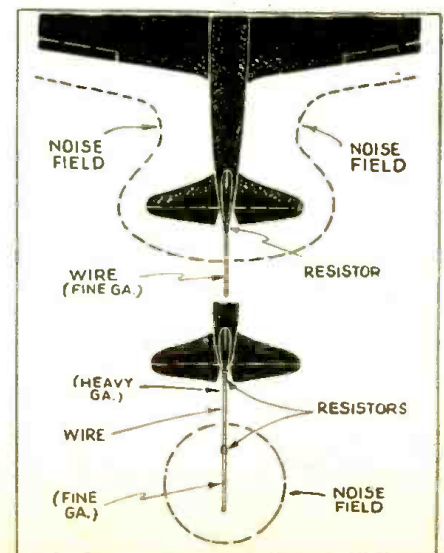

Fig. 1. Resistors remove noise-field from plane.

Please Say That You Saw It in RADIO-CRAFT

3

Precision Testers

In Compact Portable Case

An Outstanding Triplett Value...

- Model 1125-A VOLT-OHM-MILLIAMMETER
- Model 1151 ALL-WAVE OSCILLATOR
- 1166-A Free Point Auxiliary SET TESTER

1938 Models have Etched Panels and Extensive Circuit Revisions.

OTHER MODELS IN THIS SERIES INCLUDE BOTH SINGLE AND DOUBLE UNIT TESTERS.

Equipped with plug-in type copper oxide rectifier for A.C. readings. Easily renewed if accidentally burned out.

Model 1181-E is an ultra compact portable laboratory. Free Point Tester is mounted in the removable cover as shown. Compact oak case when closed measures 16½" x 7½" x 4¾". Free Point Tester Model 1166-A measures voltages, currents, resistances, and continuities without removing radio chassis from cabinet. All Wave Oscillator Model 1151 covers frequencies from 110 K.C. to 18 Megacycles. Fractional frequencies covered by accurately divided scale. Battery operated.

Volt-Ohm-Milliammeter Model 1125-A provides A.C. and D.C. voltage readings 0-15-75-150-750 at 1,000 ohms per volt. D.C. M.A. 1.5-15-150. A.C. M.A. 15-150; Ohmmeter scales 0-1500 Ohms, 1.5 and 3 Megohms. Selector switch for all readings. Batteries included.

Model 1181-E complete as above with necessary batteries and accessories . . . DEALER NET . . . \$41.83

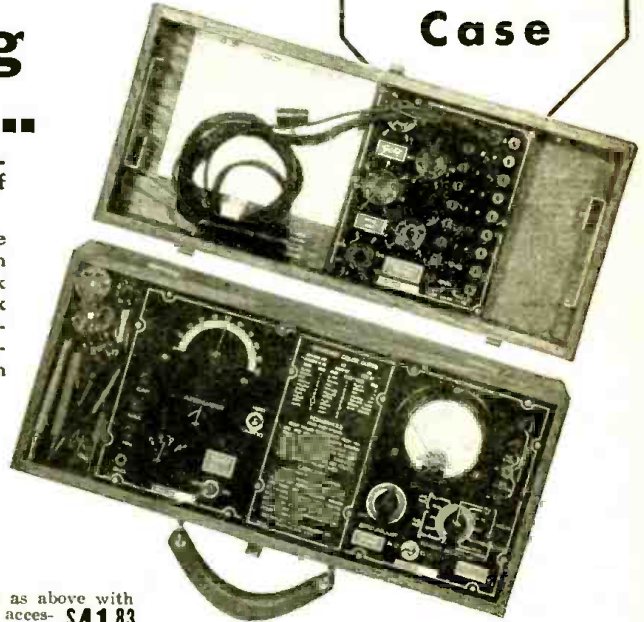

The Triplett Electrical Instrument Co.
161 Harmon Drive, Bluffton, Ohio
Please send me more information on Model 1181-E
..... I am also interested in

Name

Address

City State

SEE YOUR JOBBER
Write for More Information

HORIZONTAL AND VERTICAL DIPOLES

A pair of horizontal and vertical dipole antennas was tried on the ground with the 100,000 V. charging equipment. They were tuned and coupled to the receiver by means of an electrostatically shielded antenna transformer. Although they gave a definite improvement over corona static as compared to a single bare wire, their signal pick-up was too poor for practical aircraft use. Resonating the aluminum tube antenna previously discussed, gave some gain against corona static, but not enough to warrant its use. Under the same conditions, a receiver having a high-impedance antenna coupling system was compared with another receiver having a low-impedance antenna coupling system. The corona static to signal ratio was practically identical on both receivers.

The metallicly covered loop antennas gave the following advantages over the regular bare wire beacon antennas:

- (1) The advantage varies with the intensity of the corona discharge.
- (2) In mild snow-static the advantage as measured by R.M.S. static output of the receiver may be 20 or 30 to 1.
- (3) In heavy snow-static the advantage drops to 5 or 10 to 1.
- (4) In very heavy snow-static no range reception can be heard on any loop antenna even when flying within 2 or 3 miles of the range station.

On one test trip in a Pacific tropical-marine, warm air mass front no range reception was possible when any of the anti-static loops were used for a period of 25 minutes. Had we remained in this air mass layer we could have been without range reception for several hours, since the front was parallel to the airway. With the assistance of our meteorologists such conditions can normally be avoided, and this particular flight represents an extreme case. It does appear, however, that the anti-static loops must be coordinated with discharging systems and meteorological guidance if a complete solution is to be obtained.

It seems that the advantage of the metallicly shielded loops lies in their metal covering. An experimental, wooden nose was installed on the plane, and covered with copper foil. The foil was cut at suitable points to make a Faraday shield. An unshielded loop in this nose gave practically the same results as the loops with the metal immediately surrounding the wire. The loop in the tear drop housing gave practically the same results as the nose ring or metallicly covered loop on the plane belly. The nose ring loop was usually about 5 per cent better than the loop on the plane belly, probably because it was farther forward. A low-impedance metallic loop with an impedance-matching network gave the same results as a high impedance of the same metallicly covered construction. The wooden nose without copper foil was painted with a mixture of dope and graphite so that it had an average resistance of 20,000 ohms to the plane structure. Signal pick-up dropped about 15 per cent for loops inside this nose. No change in snow-static advantage occurred. An unshielded loop in this nose suffered from snow-static, while a metallicly covered loop in the same place gave the usual advantage. Position about the nose of the plane seemed to have very little bearing on the snow-static effects.

MISCELLANEOUS SOURCES OF STATIC

Any insulated surfaces such as windshield, de-icers and non-metallic loop housings can charge up with respect to the plane. When the charge on them becomes high and the plane suddenly flies into a higher or lower charged cloud area, these insulated surfaces will spark to the plane structure. Painting the loop housing with dope and graphite stops this source of noise. If, however, the plane flies through an icing area, an ice cap will form on top of the graphite paint. This ice cap is an insulator which charges up and sparks over in the same manner as the insulated surface. Thus in ice, the special paint does not accomplish its purpose. The answer is to streamline loop housings so that ice does not form.

For some time we have been using bakelite stubs instead of the egg-type insulators on trans-

mitting antennas to avoid ice troubles. These stubs have always followed the usual streamline form with the blunt forward edge and tapering rear edge. They also gather a thick layer of ice on the blunt forward edge. As a result of our loop housing work, we are now constructing stubs with a sharp front edge, which should completely and finally solve the antenna icing problem.

During the course of our flights we found that the bonding on one of the ring cowls had broken. This ring cowl, resting on leather pads, charged up in snow-static and sparked over at regular intervals. In average charged clouds, this sparking caused a headphone noise sounding like pebbles falling in a metal pail. Any other exposed metal parts on a plane which are not bonded would cause a similar noise. The first steps toward improving plane reception in snow-static should include a thorough inspection of all bonding.

Our work with the loops gave rise to considerable speculation as to why a shielded loop attenuated the corona radiation and an unshielded loop did not. Four theories have been advanced, but none have been carried far enough to date to warrant discussion here. All, however, must consider that the wave front of the interference is exceedingly steep as compared to that of the beacon signal. Dr. O'Day is working on a mathematical approach to the problem, which we hope will clear up this peculiarity. Once it is understood, the way may be open to a new type of antenna which does not have the disadvantages of the loop.

The loop type of beacon antenna has no cone of silence, and is practically "unflyable" when within 5 miles of a loop-type DOC radio range. To overcome this, we might assume that we can always change over to the regular antenna when close to the station so that a normal cone of silence can be obtained. It is assumed that the range signal will override the snow-static when close in. Actually, however, we have records of a number of cases where the static directly over the range station was strong enough to make changing over impossible since even the loop

Continued on page 444

Please Say That You Saw It in RADIO-CRAFT

HOW TO CONDUCT A SOUND-ON-FILM RECORDING STUDIO

(Continued from page 415)



That the Sun moves north as men travel south, until finally it shines continuously in the north.

For 1,500 years men laughed at the "gullibility" of the ancients, until, by sailing past the Equator, Europeans of the Middle Ages

DISCOVERED what the Egyptians KNEW thousands of years before.

Suppressed Knowledge of Ancient Sages

—lost to the world for 3,000 years, but preserved by the FEW who could appreciate and use it—is available to you, through association with the Rosicrucians. Their unique and successful methods of mastering life's problems and developing Personal Power are even more effective today. Try their formulas on your own personal and practical problems.

Successful? — Happy?

Have you realized the highest possibilities of which you are capable? Are you going through life with your greatest assets—social, business, intellectual—locked in a chest, without looking for the key?

Send for a Free Copy of "The Secret Heritage." It may open up a new world of personal satisfaction and practical achievement; it might have a startling effect upon your own future. It is sent free to the serious. Address Scribe E.Z.J.

The ROSICRUCIANS AMORC

San Jose California (Not a religious organization)

Send for your copy TODAY

Do You Like RADIO

TELEVISION, SOUND & ELECTRICITY

You men who want to know the true facts about employment opportunities and requirements in radio and related industries should have National's new book—40 pages of information and illustrations.

NATIONAL SCHOOLS

Dept. RC-1, 4000 So. Figueroa Street, Los Angeles, Calif. Please Send Free Book

NAME _____ AGE _____ ADDRESS _____ CITY _____ STATE _____

BOY! THIS MAKES RADIO REPAIRING A CINCH

RADIO KINK-AIDS



Practical Repairs for 3,000 RECEIVERS

Over 3,000 filed and indexed service links to repair those hard-to-fix home and auto radios. Just pull out the card corresponding to the name and model of the set you are repairing, and there you have listed the service troubles found in that radio and how to fix them.

FREE WRITE FOR BULLETIN RC-1 AND SAMPLE CARDS

AKRAD PRODUCTS CO. 362 Wooster Ave. Akron, O.

Tear out this ad, write your Name and Address in the margin, mail \$1.95 and we will send outfit at once.

room will bring complications due to excessive reverberation unless adequate precautions were taken and would be unnecessary for most purposes. At one end of the room are built 2 booths, each about 4 by 7 ft. These booths are covered with sound-absorbent material with the exception that in the doors (facing the studio) each has a glass window 2 ft. square at eye-level.

One booth is for the camera-man and his camera, while the other houses the recordist and the recording apparatus. Both technicians can thus watch the scene as it takes place and no noise from the motors in the booth can be heard outside.

REHEARSALS

Many rehearsals are often necessary before the scene begins. Unlike in radio broadcasting, the actors must not only be thoroughly familiar with their actions but must read the lines from memory. During the rehearsals, the monitor at the recording equipment listens-in and may direct a change in microphone placement or a slight change in the position of the various props (properties—tables, chairs, etc.) to obtain the clearest sound.

The recording engineer has under his control a switch for turning on red lights in the studio and the booths. When the scene is about to begin these lights are turned on as a warning for silence. The recordist then presses the switch which turns on both his recorder and the camera simultaneously.

The Clap-Stick. An assistant now steps into the camera field holding up a clap-stick. This consists of 2 metal plates hinged together with room on the faces for the number of the scene and any other information needed later in cutting. This information is photographed by the camera. The assistant now closes the clap-stick sharply causing a loud noise, and as soon as he has stepped out of the camera field the shooting of the scene begins. The above procedure is necessary to synchronize the film. The frame on the picture negative showing the 2 metal plates just closing took place at the instant that the loud noise caused a heavy overmodulation on the track. Since synchronous motors are used and since the start of the films is known, the sound and picture films will now match throughout their length.

MONITORING

There are 3 main pieces of equipment: (1) the power supply, (2) the amplifier, and (3) the recorder (see the photographs on pg. 415). On the amplifier panel are 3 major controls. The left-hand one (A) is the volume control for the non-sync. input (phonograph pickup); the center one (B) is the volume control for the microphone; the third (C) is master control for the other two. All controls are of the constant-impedance type. At the left side of the panel is an uncalibrated dial (D) to adjust the recording bulb intensity. This bulb is located in the galvanometer unit. Below this control is the head-set jack (E).

The meter in the center is used both as a level indicator and as a current meter for the recording bulb. When the button below it is depressed it reads on ampere scale, otherwise it reads in decibels to measure the modulation. Full modulation is indicated when the needle swings to 3 decibels on the peaks. A switch at the right side of the panel can be used to change-over from voice to music recordings.

There are 4 special type sockets at the top of the panel. Left to right, the 1st (F) is marked "power" and connects to the power supply. The 2nd (G) is connected to the galvanometer socket in the recorder. It supplies the modulated output, the D.C. for the recording lamp and the field current for the electromagnets. The 3rd socket (H) is used for non-sync. input (phono). The last socket (I) is for microphone. Hum pickup is minimized by the separation of power supply and amplifier into 2 units.

It is the duty of the monitor to watch the decibel meter to keep the average modulation at high level. This is similar to radio broadcasting. Also it is necessary that he note as often as possible that the bulb has not burned out, otherwise many scenes may have to be done over.

PROCESSING

When the recording is completed, the 2 films are taken from their respective magazines in a

dark room and sent to the laboratory for processing. A different developer is used for each. The films are then ready for the "cutting" room where scenes may be shortened, eliminated or a change made in their continuity. Each change made in the picture negative calls for an exact and corresponding change in the negative of the sound, otherwise the synchronization will be lost.

In splicing film the ordinary splice will not do since it causes a sharp break in the light beam falling on the photoelectric cell and a loud noise. Therefore, a special punch called a "bloomer" is used. This punches out a section of the track where the splice is made. The punched-out section is in the shape of a triangle so that the beam of light in the projector will now be interrupted gradually and no sound will result.

The picture is now ready for printing, that is the finished positive is to be made. The picture is printed first, the track section being masked off in the printer; and then the sound is put on, the picture part being masked off. The start of the sound, however, is printed 1 1/2 frames or 14.4 ins. AHEAD of the start of the picture. The reason for this is that in projecting it is naturally impossible for the 2 apertures to be in the same place on the projector. It is necessary for the print to be run through one aperture and then pass through the other. The standard adopted has been to place the sound aperture 14.4 ins. ahead (in the direction of the film travel) of the picture aperture. The sound film is now ready for run-off.

MAINTENANCE OF EQUIPMENT

It is essential that the equipment be kept in first-class condition at all times. The apparatus is subject to use at a few minutes' notice so that tubes, motors, etc., must be kept inspected frequently.

This particular outfit is sometimes used in a D.C. district in the heart of Boston so that a motor-generator set for supplying A.C. 60-cycle current must be used. A 4-terminal starter is used for the motor. The total A.C. used by both synchronous motors, amplifier, etc., is about 8 A. An essential part of the equipment is a frequency meter to measure the line input frequency. A reed type is used for the purpose. For possible servicing and repair work on the amplifier, power supply and general equipment, an analyzer is always kept in the booth.

A complete diagram covering both amplifier and power supply is shown in Fig. 4. Only the highest grade parts can be used in such a system due to the exceptionally low powers dealt with. Four tubes are used in the amplifying system; and 2 rectifiers are a part of the power supply. The 84 supplies high voltage for the various tubes, while the EL-22, a high-current rectifier, supplies 6 V. for the recording bulb, field magnets and also the filament voltage for the first 76 tube. Very low hum output results from the D.C. power on its filament.

The 2 input sockets are shown at the left. The microphone input is applied at the control-grid



The "clap-stick" which the assistant is holding in the camera field is a device which is mighty useful in the subsequent editing, cutting, and synchronization of the "talkie".

Please Say That You Saw It in RADIO-CRAFT

of the first tube through a transformer, while the non-sync. input is sent only through the last 3 tubes.

The microphone used is a W.E.-630-A type dynamic. The output is exceedingly low, having an average of only 10⁻¹¹ watts. Because of this the connecting cables must be shielded from all possible sources of induction and the shielding grounded. Also the impedance, approximately 30 ohms, should be matched for best quality and to prevent loss of energy. Lately, W.E. developed a non-directional baffle to be used with this microphone.

To keep the high-frequency response up, so necessary with sound-on-film, equalizers are inserted in the circuit. The last tube is a 6E6, composed of 2 triodes. They are connected in push-pull to eliminate 2nd-harmonics. The output is transformer-coupled, the impedance of the secondary being approximately 50 ohms to match the galvanometer winding. The master volume control is indicated in the input circuit to the 2nd type 76 tube, while the other 2 are connected just ahead of the transformer, coupled to the 6C6 input.

The diagram of the mixer circuit and the equalizer circuit indicated in Fig. 4 are shown in Fig. 5. The words "note (x)" and "note (φ)", code words used by the manufacturer, denote (respectively) an equalizer and a high-pass filter.

The Equalizer. The equalizer placed after the 76 is used for the purpose of emphasizing the high frequencies at the expense of the lower ones. It is the usual communications type of equalizer. (See Fig. 5A.) The assembly, L/C, is tuned to approximately 6,000 cycles and offers high impedance to frequencies at about this range. The resistance, R, in series with this circuit is for the purpose of flattening out the curve of frequencies passed on. Systems for aiding the high frequencies are necessary with sound-on-film

installations since in reproducing there is always a tendency to lose them. In other words, since frequencies in the neighborhood of 7,500 cycles and up result in extremely thin lines on the film it becomes difficult to record them. Also, for the same volume, a high note means that the galvanometer must move back and forth faster than for a low note. If it were possible to move the film past the slit faster in recording and reproducing then, of course, a still greater range of high frequencies would be available, and so on. For instance, in 16 mm. recording, since the film travels 2/5 of the 35 mm. speed, the high frequencies suffer even more and still greater precautions must be taken if good quality is wanted. It is necessary, then, that an amplifier for sound-on-film use must always overemphasize the high frequencies to result in a straight-line characteristic in the final film reproduction.

It will be noticed that although a switch (marked "in" and "out") is available with the equalizer, it is always kept in the circuit. The equalizer is placed in the circuit so that it is effective both on non-sync. (phono. disc) and sync. recording, that is just before the 2nd stage.

The Mixer. The diagram of the mixer circuit, also, is shown in Fig. 5A. These are constant-impedance pads of 30 ohms resistance and are connected in series, their output going to the equalizer and the next transformer. For example, an increase in one control (say, the sync.) and a decrease in the non-sync. control will, of course, fade-in the sync. input and fade-out on the non-sync. as in usual sound procedure. The master control for increasing or decreasing the combined inputs of the mixer, is placed just before the 2nd 76.

The Low-Pass Filter. The low-pass filter is shown in Fig. 5B. This is the unit shown in Fig. 4 as Note (φ).

The box marked UC-35, etc., is the decibel-ammeter which is shown in the center of the amplifier panel in the photos. Note from the connections that depressing the button results in the meter being an ammeter while release causes it to be a db. meter. The current meter is used, of course, to measure current to the 6-V. bulb in the galvanometer assembly and the decibel meter is used to measure the level of the output (A.F.) (Characteristic data concerning the EL-type heavy-current rectifiers appear in the article "Uses of Low-Voltage Thermionic Rectifiers" in the April 1936 issue of Radio-Craft.—Editor)

CONCLUSION

It is hoped that this article has given to the readers of Radio-Craft a better understanding of talking picture procedure. Many new developments in this field are being worked out in research laboratories and will in time be in common use, but the foregoing principles are basic and a knowledge of them will still be necessary. (The reader may also wish to study the 3-Part article, "Servicing Theatre Sound Systems," which started in the December, 1935 issue of Radio-Craft, for additional information on the subject of talkies.—Editor)

This article was prepared in 2 parts, Chapter I, "Principles of Recording" was so long as to require 2 issues of Radio-Craft and therefore appeared in the November and December issues. Chapter II, "The Studio," appears in this issue of Radio-Craft. The editors—and the author, too!—will be very much interested to receive reader comments pro and con concerning articles on this subject.

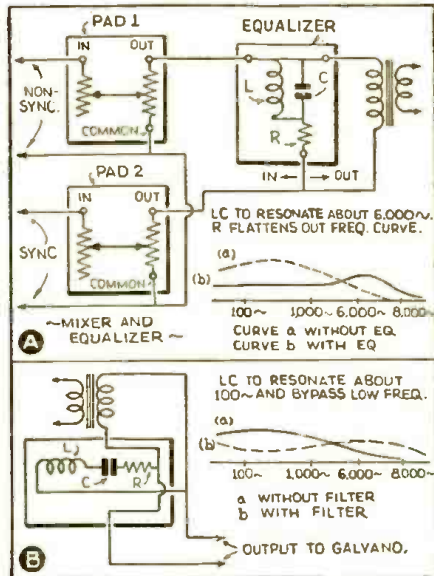

Fig. 5. Circuit details of (A) "mixer" and "note (x)" (high-pass filter), and (B) "note (φ)" (low-pass filter), in Fig. 4.

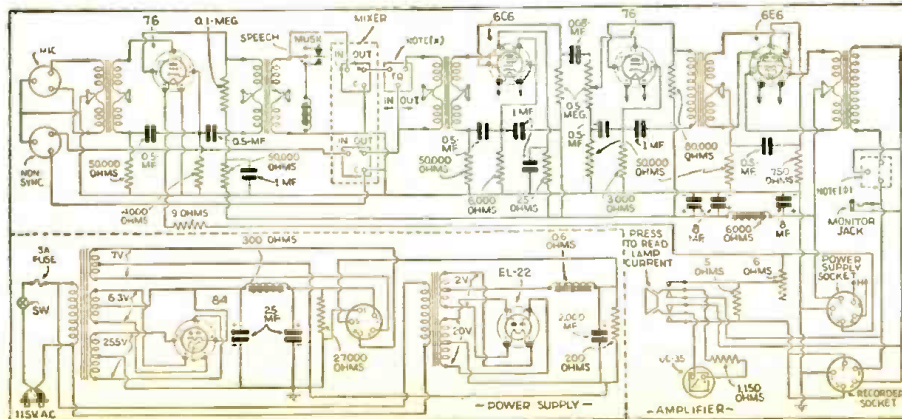

Fig. 4. Diagram of complete amplifier. Galvanometer connects at Recorder Socket.

Please Say That You Saw It in RADIO-CRAFT

YOU CAN AFFORD THESE RIDER BOOKS



BUT YOU CAN'T AFFORD TO BE WITHOUT THEM

NEW

VIBRATOR POWER SUPPLIES
by Garstang and Rider

It becomes increasingly important that servicemen have the information on vibrator supply systems which is contained in this book. For vibrators are used in auto radio sets, 32-volt farm receivers, mobile P. A. systems, coin-operated music machines, etc. 280 pp. Handsomely illustrated. \$3.00

JUST OUT

AUTOMATIC FREQUENCY CONTROL SYSTEMS
by John Rider

With Automatic Frequency Control Circuits in most new higher-priced models, knowledge of "AFC" means money in your pocket! Learn the practical facts, from these easy-to-understand explanations. Get your copy today. Cash in on profitable "AFC" work. Hard covers. 144 pp. \$1.00

REVISED

SERVICING SUPERHETERODYNES

Changes, changes, changes! That has been the history of the superheterodyne circuit. Make repairs quickly by analyzing the different parts of the circuit quickly. Rider shows you how in this revised edition which has 288 profusely illustrated pages. \$1.00

POPULAR

THE CATHODE-RAY TUBE AT WORK

Written especially so you can understand the subject. With introduction of new, cheaper Cathode-Ray Tubes, this book is even more indispensable for its complete practical information on Oscillographs, etc. 336 pp. 450 illustrations. \$2.50

HOOR A DAY

WITH RIDER BOOKS —60¢ each

ON AUTOMATIC VOLUME CONTROL will speed up your AVC work. 96 pp. 65 illus.
ON RESONANCE & ALIGNMENT. You need this! 96 pp. 48 illus.
ON D-C VOLTAGE DISTRIBUTION IN RADIO RECEIVERS. How d-c voltages are led to tube elements, etc. 96 pp. 69 illus.
ON ALTERNATING CURRENTS IN RADIO RECEIVERS—with drawings and diagrams.

WRITE TODAY FOR THE COMPLETE LIST OF BOOKS BY THE PUBLISHERS OF RIDER MANUALS

JOHN F. RIDER, PUBLISHER
1440 Broadway, New York City

YOU NEED ALL 8 Rider MANUALS

NEW TUBES FOR SHORT WAVES, PUBLIC ADDRESS AND OTHER SERVICES

(Continued from page 399)

which this ultra-shortwave, multi-service tube may be used are given in Table I. (For definition of the term perveance see (*) at end of article, pg. 433.)

(Data courtesy RCA Radiotron.)

AMPLIFIER TUBES

6AC5G Positive-Grid Class A Power-Amplifier Triode. This tube, shown in Fig. A, has been designed for set manufacturers to use in A.C. set models nominally employing the type 41 power tube. Terminal connections are shown in Fig. 1; characteristics are given in Table II.

The 6AC5G offers a low-cost method of increasing the number of tubes in a set while definitely improving the quality and performance. The 6AC5G, a positive-grid class A power-amplifier triode, is similar to the output section of the well-known type 6B5, and requires a type 76 driver tube to be connected with it in the usual "dynamic coupling" type of circuit as shown in Fig. 3. (It is believed that this circuit for dynamic-coupled operation is covered by patents controlled by Revelation Patents Holding Co.)

The type 76 tube performs the same function as the input section of the 6B5. While the positive-grid characteristic of the 6AC5G suggests typical class B service, the tube has been designed to give optimum performance in class A service with the 76 driver. *Other similar types of triode tubes than the 76 will not operate efficiently as drivers because of the differences in amplification factor and plate current.*

Many set manufacturers have increased the number of tubes in certain models to secure greater sales appeal, but have resorted to using separate diode detector and voltage-amplifier tubes instead of using a type 75, or have operated 2 tubes at reduced efficiencies.

The cost of the 6AC5G-76 combination, on the other hand, is less than other methods of increasing the number of tubes because of its simplicity. In a typical set with a 41 output tube this combination simply requires the addition of a 76 tube and socket and it eliminates the 41 tube's grid-bias resistors and filter condensers. (Name of manufacturer furnished upon request.)

6F8G Heater-Type Voltage Amplifier Twin-Triode. The 6F8G is a twin-triode type amplifier tube designed for service as a voltage amplifier. The ratings and electrical characteristics of each triode unit are identical with those of the type 6J5G. The triode units are independent of each other as the elements of each triode are brought out to separate terminals.

This tube is illustrated in Fig. A; terminal connections are given in Fig. 1. Characteristic data are given in Table III.

(Data courtesy Raytheon.)

1221 Special Non-Microphonic Triple-Grid Amplifier Pentode. (Type 1221—unless set makers take up the tube, in which case, it may then be given an R.M.A. number—is the permanent designation.) The type 1221 tube is a sharp cut-off pentode with low microphonic response. It is identical in characteristics to the type 6C6 and has the same base pin arrangements. Because of special design features this new tube is recommended especially for use where a tube of low microphonic response is necessary.

The tube is shown pictorially in Fig. A; its terminal connections, in Fig. 1; and "specs.", in Table IV. Its circuit application is described in operation as a biased detector.

Biased Detector. The 1221 is particularly useful as a biased detector because of its ability to deliver a large A.F. output voltage with little distortion when a small R.F. signal is applied to the control-grid, provided the coupling device is satisfactory.

(Data courtesy Hygrade Sylvania.)

1612 Low-Microphonic, Low-Noise-Design Pentagrid Amplifier. (Type 1612—unless set makers take up the tube, in which case, it may then be given an R.M.A. number—is the permanent designation.) This all-metal, multi-electrode tube is designed with 2 separate control-grids. This design permits each control-grid to act independently on the electron stream. *The 1612 is particularly suited for use as a volume-control tube in audio-frequency circuits critical as to microphonics.* This tube is shown in Fig. A. The tube terminal connections are shown in Fig. 1.

In A.F. amplifier circuits, the 1612 is useful as a volume-control tube to provide remote control of gain by means of a D.C. controlling voltage. In this service, the A.F. signal voltage is applied to grid No. 3 and the controlling voltage is applied, either manually or automatically, to grid No. 1. For curves and additional information on the installation and application of the 1612, refer to the type 6L7.

The base pins of the 1612 fit the standard octal socket which may be installed to hold the tube in any position. See Table V for characteristic data.

(Data courtesy RCA Radiotron.)

BALLAST TUBE

K49C-B Ballast Tube. The type K49C-B is a resistance tube designed for use as a voltage-dropping resistor in the filament circuit of A.C.-D.C. receivers. A ballast resistor tap provides voltage for one or two 6.3 V. pilot lamps.

The tube is illustrated pictorially in Fig. A; terminal connections appear in Fig. 1. (The K49C-B is also used for orders calling for K49C, as well as those specifying the "C-B" type, as the K49C is no longer stocked or produced.)

The pilot-lamp section of this ballast tube is a resistor which changes from a low value of resistance with the tube cold to several times its initial value as the tube heats. This limits the peak voltage applied to the pilot lamps to a value within their rated voltage, and operates the lamps at a higher voltage than with a straight resistance tube, *increasing the life and final brilliancy of the lamps.*

Another important feature of the ballasting action and one which will be of special interest to Service Men and experimenters, is that it permits using several different types of pilot lamps with satisfactory results. The characteristic curves of Fig. 2 show the relation between pilot-lamp voltage and time for a typical K49C-B tube, and a typical straight resistance tube with similar ratings.

(Data courtesy Raytheon.)

The resistors in the K49C-B are operated in air and the ballasting action obtained in the part shunted across the pilot lamps is due to the heat of the total windings. The resistors operate at relatively low temperature and their resistance characteristics are permanent if the normal rated current is not exceeded.

See Table VI for further characteristic data. (Data courtesy Raytheon.)

AMPERITE

presents
THE ACOUSTIC COMPENSATOR



3 IMPORTANT USES

(1) The Acoustic Compensator enables you to lower or raise the response of the microphone by the mere flip of the finger!
(2) Makes the Velocity immediately adjustable to close talking or distant pickup.
(3) Immediately adjustable to any type of job or occasion.

MODELS RBHk, RBMk. with acoustic compensator. Frequency range 40 to 11,000 CPS. Output.—65 db. Switch, cable connector, 25' of cable. **\$42.00 LIST**

MODELS RBHn, RBMn. without acoustic compensator **\$42.00 LIST**

MODELS RAH-RAL. excellent for speech and music. Reduces feedback. Output.—68 db. **\$22.00 LIST**

NEW! **AMPERITE CONTACT MICROPHONE.** for use on all string instruments. . . . **\$22.00 LIST**
AMPERITE "HAND-I-MIKE." smallest velocity mode; used as hand, desk, or stand mike. **\$22.00 LIST**

Write for new Illustrated Bulletins.
FREE: Window Decal & Window Display; also new sales helps.

AMPERITE Co. 561 BROADWAY, N. Y.

AMPERITE Velocity MICROPHONE

MILLION TUBE TESTER



FEATURES

- Emission
- Metal Tubes
- Shorts Hot
- Leakage Hot
- Resistance
- Electrolytics
- By-Pass
- Condensers
- D'Arsonval Meter

MODEL CP
\$13.95
NET

MODEL TM \$16.95 Has 3" square meter and continuous line voltage adjustment.
Direct orders require deposit and name of your Jobber.

MILLION RADIO AND TELEVISION LABORATORIES
559 N. UNION ST., CHICAGO, ILL.

QUALITY

has given Wright-DeCoster, Inc. its present standing and its enviable line of Distributors throughout the world.
Write for literature and name of our nearest Distributor.

WRIGHT-DE COSTER, Inc.
2251 University Ave., St. Paul, Minn.

RADIO ENGINEERING

RCA Institutes offer an intensive course of high standard embracing all phases of Radio. Practical training with modern equipment at New York and Chicago schools. Also specialized courses and Home Study Courses under "No obligation" plan. Catalog Dept. RT-38.

RCA INSTITUTES, Inc.
A Radio Corporation of America Service
75 Varick St., New York 1154 Merchandise Mart, Chicago

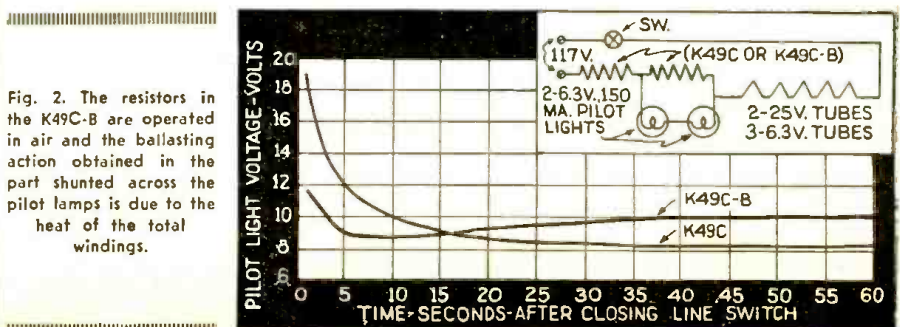

Please Say That You Saw It in RADIO-CRAFT

CHARACTERISTIC DATA

809—TABLE I

Tentative Characteristics and Ratings

Filament voltage (A.C. or D.C.)	6.3 V.
Filament current	2.5-A.
Amplification factor	50

Direct Interelectrode Capacities

Grid-Plate	6.7-mmf.
Grid-Filament	5.7-mmf.
Plate-Filament	0.9-mmf.

Maximum Ratings and Typical Operating Conditions

As A.F. Power Amplifier and Modulator—Class B

D.C. plate voltage	750 (max.) V.
Max.-signal D.C. plate current	100 (max.) ma.
Max.-signal plate input	75 (max.) W.
Plate dissipation	25 (max.) W.

As R.F. Power Amplifier—Class B Telephony
Carrier conditions per tube for use with a max. modulation factor of 1.0

D.C. plate voltage	750 (max.) V.
D.C. plate current	50 (max.) ma.
Plate input	37.5 (max.) W.
Plate dissipation	25 (max.) W.

As Plate-Modulated R.F. Power Amplifier—Class C Telephony

Carrier conditions per tube for use with a max. modulation factor of 1.0

D.C. plate voltage	600 (max.) V.
D.C. grid voltage	-200 (max.) V.
D.C. plate current	83 (max.) ma.
D.C. grid current	35 (max.) ma.
Plate input	50 (max.) W.
Plate dissipation	17.5 (max.) W.

As R.F. Power Amplifier and Oscillator—Class C Telephony

Key-down conditions per tube (ordinarily) without modulation.

D.C. plate voltage	750 (max.) V.
D.C. grid voltage	-200 (max.) V.
D.C. plate current	100 (max.) ma.
D.C. grid current	35 (max.) ma.
Plate input	75 (max.) W.
Plate dissipation	25 (max.) W.

6AC5G—TABLE II Characteristics

Heater	coated uni-potential cathode
Voltage	6.3 A.C. or D.C.
Current	0.4-A.

Class A Power Amplifier

Plate voltage	250 (max.) V.
Control-grid voltage	+13 V.
Plate current	32 ma.
Control-grid current	5.0 ma.
Amplification factor	125
Plate resistance	36,700 ohms
Transconductance	3,400 micromhos.
Plate dissipation	10 (max.) W.

Typical Operation

Class A Dynamic-Coupled Amplifier Employing Type 76 Driver

Plate supply	250 V.
Driver plate current	5.5 ma.
Power section plate current	32 ma.
External control-grid bias*	0 V.
Load resistance	7,000 ohms
Rated power output	3.7 W.
Harmonic distortion	10%
Signal volts for rated output	16.5 r.m.s.
Max. power output (start of driver grid-current)	4.3 W.

*Bias voltage for both the driver and power sections is automatically developed by the dynamic-coupled connection and driver grid-current does not flow during any part of the cycle up to 4.3 W. output.

A 25,000-ohm resistor should be connected between control-grid and cathode of the power tube to prevent a current surge occurring while the tube is warming up. The total resistance in the type 76 control-grid circuit should not exceed 1 meg.

6FR8—TABLE III Characteristics

Heater voltage (A.C. or D.C.)	6.3 V.
Heater current	0.6-A.
Max. plate voltage	250 V.

Amplifier (Each Triode)

Plate voltage	250 V.
Control-grid bias	-8 V.
Amplification factor	20
Plate resistance (approx.)	7,700 ohms
Transconductance (approx.)	2,600 micromhos.
Plate current	9 ma.

The voltage between heater and cathode should be kept as low as possible where they are not directly connected.

Direct Interelectrode Capacities

		TRIODE 2 (Triode 1 to Ground)	TRIODE 1 (Triode 2 to Ground)
Grid-Plate		4.5	4.16 mmf.
Input		3.3	3.0 mmf.
Output		1.5	2.0 mmf.
Grid-Grid		0.13	mmf.
Plate-Plate		1.2	mmf.
Grid 1-Plate 2		0.2	mmf.

1221—TABLE IV Characteristics

Heater voltage (A.C. or D.C.)	6.3 V.
Heater current	0.3-A.

Operating Conditions and Characteristics

		Triode Amplifier	Pentode
Heater voltage		6.3	6.3 V.
Plate voltage		250	100
Control-grid voltage		-8	-3
Screen-grid voltage		-	100 (max.) V.
Suppressor-grid		Tie to cathode	
Plate current		6.5	2.0
Screen-grid current		-	0.5
Plate resistance		0.01	1.0
Mutual conductance		1,900	1,185
Amplification factor		20	1,185

Operating Conditions as Biased Detector

		Detector	
Heater voltage		6.3	6.3 V.
Plate voltage		100	250 V. (max.)
Control-grid voltage		-1.8	-4.3 V. approx.
Screen-grid voltage		30	100 V. (max.)
Plate load, 250,000 ohms, or 500 hy. choke shunted by 0.25-meg. For resistance load the plate supply voltage will be voltage at plate plus voltage drop in load caused by specified plate current.			

Direct Interelectrode Capacities

Grid-Plate (with tube shield)	0.010-mmf. max.
Input	5.0 mmf.
Output	6.5 mmf.

1612—TABLE V

Tentative Characteristics

Heater voltage (A.C. or D.C.)	6.3 V.
Heater current	0.3-A.

As Amplifier—Class A

Plate voltage	250 (max.) V.
Screen-grid voltage (Grids Nos. 2 and 4)	100 (max.) V.
Control-grid voltage (Grid No. 1)	-3 (min.) V.
Control-grid voltage (Grid No. 3)	-3 V.
Plate current	5.3 ma.
Screen-grid current	6.5 ma.
Amplification factor	880
Plate resistance	0.8-meg.
Transconductance (Grid No. 1-Plate)	1,100 micromhos.
Transconductance (Grid No. 1-Plate): with -15 V. bias on Grid No. 1	5 micromhos.
with -15 V. bias on Grid No. 3	5 micromhos.

Direct Interelectrode Capacities:

Grid No. 1-Grid No. 3	0.12-mmf.
Grid No. 1-Plate	0.0005-(max.) mmf.
Grid No. 3-Plate	0.025-mmf.
Grid No. 1-all other electrodes	8.5 mmf.
Grid No. 3-all other electrodes	11.5 mmf.
Plate-all other electrodes	12.5 mmf.
*Shell connected to cathode	

K49C-B—TABLE VI Characteristics

Voltage drop at 300 ma.	49 V.
Supplies correct filament voltage to:	
3-6.3 V. 300 ma. tubes and	
2-25 V. 300 ma. tubes in series	
Pilot lamp voltage at 300 ma.:	
2-6.3 V. 150 ma. lamps in series	10 V.
1-6.3 V. 200 ma. lamp	6.6 V.
1-6.3 V. 250 ma. lamp	4.8 V.

* (Transmitting-tube *perveance*, previously mentioned, is a measure of tube conductance and of the total space current that can be drawn from the tube under particular electrode voltage conditions, states the manufacturer of the type 809 tube. *Perveance* is dependent on tube structure. Because it takes into account the large plate-current pulsations in transmitting tubes as well as the tube conductance, it is a more useful term for transmitting tubes than *transconductance*. A tube of high *perveance* conducts high current at high plate-current efficiencies with good power amplification.)

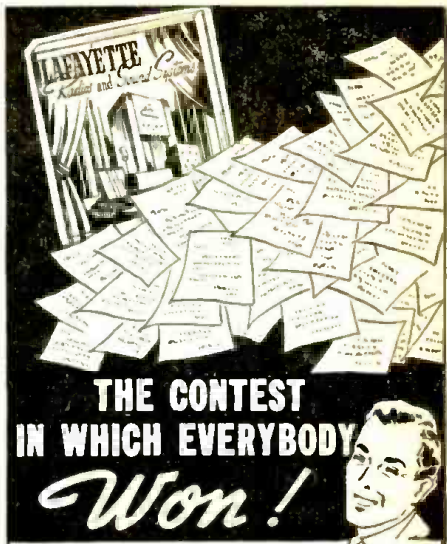

THE CONTEST IN WHICH EVERYBODY Won!

Here are the prize winners in Wholesale Radio Service Co.'s great contest:

- ★ FIRST PRIZE (\$250.00) W. E. McLAINE, MARSHALL, MICHIGAN
 - ★ SECOND PRIZE (\$150.00) JACK E. BANNON, OIL CITY, PENNSYLVANIA
 - ★ THIRD PRIZE (\$100.00) CLINTON L. KINZEY, INDEPENDENCE, MISSOURI
- and 50 others who won \$10.00 each

What a contest! From all over the world the letters poured in. To each enthusiastic entrant went a copy of the big new WHOLESALE Catalog with its 50,000 listed items at rock-bottom prices. 180 pages indexed for easy reference. A "goldmine" of radio values right at your elbow. Every one of you who got this catalog is a winner—for you'll save dollar after dollar by making your purchases from its pages. Here's just a sample of what the catalog includes:

PUBLIC ADDRESS EQUIPMENT

Page upon page of famous Lafayette P.A. systems in all sizes for every conceivable demand or requirement. There's money in this new field and the FREE catalog shows you how to make it! Whether you rent, sell or install, you'll want this book.

LAFAYETTE RECEIVERS

35 pages devoted to Lafayette's new line for 1938—70 brilliant models. Priced so low you can have that "extra set" at last. Study the receivers illustrated in the FREE catalog. Discover what real radio value is.

TEST AND HAM EQUIPMENT

The greatest collection of up-to-tomorrow test instruments you've ever seen. To delight the "ham"—every nationally advertised make of amateur equipment. All in the FREE Wholesale catalog at prices that cannot be beaten.

MAIL THIS COUPON NOW

WHOLESALE RADIO SERVICE CO. INC.
NEW YORK, N.Y. • CHICAGO, ILL. • ATLANTA, GA.
100 SIXTH AVENUE, NEW YORK, N.Y. • 901 W. JACKSON BLVD., CHICAGO, ILL. • 430 W. PACHTER ST., N.W., BOSTON, MASS. • BRONX, N.Y. • NEWARK, N.J. • JAMAICA, L.I.

WHOLESALE RADIO SERVICE CO., INC.
100 SIXTH AVENUE, NEW YORK, N. Y.

Rush FREE 1938 catalog No. 69-3A8
Rush FREE Xmas catalog No. 70-3A8

NAME _____
ADDRESS _____
CITY _____ STATE _____



THE LATEST IN SERVICING

The Infinometer

A REALLY ACCURATE, STABLE AND SIMPLE TO OPERATE V.T. VOLTMETER FOR BOTH A.C. AND D.C. MEASUREMENTS.

ONLY \$14.40 COMPLETE

8 BIG FEATURES!!

- Solves Complicated AVC and AFC Circuit Defects Quickly and Simply. Will Absolutely and PRECISELY Measure AVC Voltages In Any Receiver Circuit.—Without Upsetting Operating or Electrical Conditions.
- Measures Grid-Bias in R.F. and A.F. Stages ACCURATELY Even When Units Are in Operation. Without Interference or Detriment to Operation.
- Measures Voltage Gain as Well as Input and Output Voltages in any Vacuum Tube Stage. This will Permit Servicemen to Gauge the Efficiency of Sets, Amplifiers, etc.
- Measures Critical Voltages in Low-Current Circuits, Such as in Volume Expanders, Detectors, Oscillators, Noise-Suppression Stages, DC Amplifiers, Photo-cell Circuits, Etc.
- Make Accurate AC and DC Voltage Measurements in any Receiver, Amplifier or Electrical Circuit, Within the Ranges Specified.

- Make All Measurements QUICKLY. No Involved "Balancing-Out" Processes or Meter Instability Encountered.
- Operates From 110 Volts DC or AC (any frequency). With Less Than 5% Error on High Voltage Ranges Due to Line-Voltage Fluctuations.
- Three DC Ranges: 0-6, 20 and 60 Volts; Four A.C. Ranges: 0-5, 15, 50 and 150 Volts. Sensitivity approximately 700,000 Ohms per Volt on DC Ranges; Approximately 300,000 Ohms per Volt on AC ranges.

WHY THE INFINOMETER? This instrument has been especially designed and priced to meet servicemen's needs for a practical Vacuum Tube Voltmeter developed to record accurate measurements in low current radio circuits. A selector switch and zero adjuster are included to enable a variety of voltage ranges and quick meter adjustment for idling plate current in the V.T. circuit. Employs 3 tubes, 2-76, 1-6C6. Instrument is adequately shielded; meter (microammeter) directly calibrated. Supplied with complete operating instructions. For complete technical details on the INFINOMETER and other SUPERIOR TEST INSTRUMENTS write for Catalog JB.

SUPERIOR INSTRUMENTS COMPANY 136 LIBERTY STREET
Dept. JB New York, N. Y.

HOW TO MAKE THE 4-TUBE "SHORT-WAVE SPECIAL"

(Continued from page 397)

- One Solar tubular condenser, 0.1-mf.;
- One I.R.C. variable resistor, 20,000 ohms, R1;
- One I.R.C. resistor, 300 ohms, 1/2-W.;
- One I.R.C. resistor, 200 ohms, 1/2-W.;
- One I.R.C. resistor, 20,000 ohms, 1/2-W.;
- One I.R.C. resistor, 50,000 ohms, 1/2-W.;
- One I.R.C. resistor, 1 meg., 1/2-W.;
- Two I.R.C. resistors, 0.5-meg., 1/2-W.;
- One I.R.C. resistor, 50,000 ohms, 1 W.;
- One I.R.C. resistor, 20,000 ohms, 1 W.;
- One I.R.C. resistor, 600 ohms, 1 W.;
- One Standard Transformer Corp. midjet-type;
- One aluminum panel, 12 x 7 x 1/16 ins. thick;
- One aluminum chassis, 11 x 6 x 1 1/2 ins. high;
- One midjet jack.

†Most Radio mail order houses can supply this item if properly identified as to title of article, issue (month) of Radio-Craft and year.

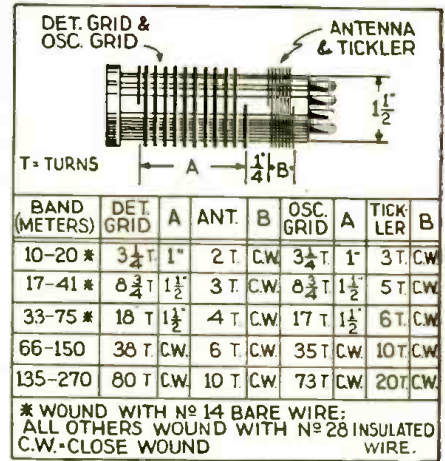

Fig. 3. Here's the data to make your own coils.

\$500,000 GENUINE MAJESTIC GRIGSBY GRUNOW REFRIGERATOR & RADIO PARTS. UNITS GUARANTEED 18 MONTHS. SEND FOR PRICE LIST. G & G GENUINE MAJESTIC REFRIGERATOR & RADIO PARTS SERVICE. 5801 W. DICKENS AVE. CHICAGO, ILL.

RADIOS..SAVE UP TO 50% DEAL DIRECT...FACTORY PRICES! Many models to select from: AC-DC All-Wave; armchair models; automatic tuning; car radios; Farmettes that operate like city radios! Send postcard for NEW Bargain Catalog FREE, 30-DAY TRIAL! Dial and agent-user proportional. GOLDENTONE RADIO CO. DEPT. B1, DEARBORN, MICHIGAN. Free Catalog

RADIO COURSES RADIO OPERATING: Prepare for Gov't License Exam. ● RADIO SERVICING: Including Short Wave ● AMATEUR CODE ● ELECTRONICS ● TELEVISION Day and Evening Classes—Booklet Upon Request. New York YMCA Schools. 4 W. 64th Street, New York City

RADIO IN IT'S ENTIRETY! "B.A." serves the trade with every need in radio—complete 160-page catalog of nationally known radio receivers, public address, parts, supplies and equipment. Orders shipped same day received. COMPLETE CATALOG AVAILABLE BURSTEIN-APPLEBEE CO. 1023-14 McGEE ST. KANSAS CITY, MO.

WANTED - MEN to east Christmas Goods, 5 and 10c Novelties, Toy Autos, Ashtrays, etc. Can be done in any spare room, basement or garage and no experience necessary. A rare opportunity to devote spare or full time to profitable work. WHITE DEPT. 26. METAL CAST PRODUCTS CO. 1696 Boston Road New York City

OPERATING NOTES

(Continued from page 407)

output tube is a fairly common complaint; it is almost a routine with me to replace the audio coupling condenser, since this part so frequently breaks down.

Just lately, however, I have had several cases where the usual symptoms of upset plate voltages, and the like, were absent; and instead there was hum, audio oscillation, alternate loud and soft reception and intermittent roaring noise.

Upon investigation it was found that the resistance of the coupling condenser had lowered just enough to upset the pentode bias, reducing it to about zero; and the varying signal voltage apparently did the rest. The troubles naturally disappeared with replacement of the condenser.

Serenader Old 70 (Grimes). Although the trouble described was most characteristic of the above model, it has been found in some other Grimes' models as well as sets of other makes. The symptom is just "microphonics." Simply this and nothing more; but on the set I have in mind everything that apparently contributed to the trouble was insulated with sponge rubber from its neighboring parts and from the chassis; the tubes were thoroughly gone over, and even the speaker was mounted on rubber, but it still howled. When every other effort failed, as a last resort the oscillator coil was changed, and trouble disappeared like magic!

The troublesome coil had been painted with insulating cement, but apparently that was not enough; the new coil was one which had been dipped in wax, and is one which the factory now recommends for replacement.

T. C. RUMNEY, Toronto, Ontario, Canada

Sparton Model 594. "Set dead." was the complaint. The trouble was found to be caused by the type 75 2nd-detector—A.V.C. tube cathode resistor being open; and a defective volume control. The value of the cathode resistor is 100 ohms; volume control, 0.5-meg. Replace the type 78 1st-detector—oscillator. Check the 25Z5 in that

it may have flashed. If so, replace the filter condensers, as they sometimes have a habit of opening and healing again, causing the 25Z5 to flash. Replace with a new condenser and tube.

Wells-Gardner Auto-Radio Series 6S. Set inoperative due to an open filter choke (L). Check the electrolytic filter condensers (C26, C27) for "short." Replace with ones of higher value in voltage rating. These constitute a dual unit, capacity 6 and 8 mf., 350 V. Change to 400 V., also checking the 84 rectifier for internal short, as I have found a few of these in such condition. GEO. F. BAPTISTA

Majestic Model 25M Chassis. We recently had a very unusual case of fading in this set. When the set was first turned on and tuned in, when warming up, the set would operate OK for about 1 or 1 1/2 minutes, then fade out (on any station). Retuning the set would restore the volume to normal. (Dial setting would be 10 kc. higher after retuning.)

A very careful check of the set and voltages was made; also resistance tests. All tests indicated everything to be OK.

The nature of the trouble led us to suspect the oscillator circuit, which used a type 227 tube. The trouble was finally located in the 8,000-ohm, 2-W. resistor in the "B+" circuit (carbon resistor—feed plate 27 osc.).

The trouble in this case was due to the fact that this resistor tested OK (hot or cold) at the metal ends on the resistor, but when tested from one end of the pigtail leads to the other pigtail, we found that one of the pigtails was making a poor contact with the metal cap on the end of resistor. Result: high resistance joint which varied with the heat of the carbon resistor when the resistor warmed up and tightened the contact. Of course, reception was improved and set was OK when resistor was replaced with a wire-wound unit.

A. R. HIRD, Toronto, Ont.

Please Say That You Saw It in RADIO-CRAFT

THE RADIO MONTH IN REVIEW

(Continued from page 391)

other undesired effects in the nearby service area. It is expected to increase efficiency tenfold, as regards "local" reception.

Another feature of the antenna system is a "ground" of 360 No. 8 copper wires, radiating from the foot of the mast to a distance of 700 feet. These, laid in shallow trenches dug by a tractor, are 48 miles in length overall and give a perfect counterpoise.

RADIO BUSINESS AND CONDITIONS

UNCLE SAM—at least the Internal Revenue Dept.—told the R.M.A. last month that makers of Private Address systems must pay 5% on all components "suitable for use in radio receiving sets," whether or not so used.

Automatic-tuning sets are commonly set to large stations, and drop small ones off the visiting list. WTEL, Philadelphia, last month put on announcements requesting purchasers of new sets to tell the Service Man to include that call on the dial.

London retailer, A. Gray, last month staged an exhibit of both home talks and television, to prove to customers that 2 types of entertainment do not conflict but are "different forms with separate appeals," says *Wireless Retailer*.

Associated Press, newspapers' organization, was last month considering including commercial radio field in its service, without requiring newspaper affiliation, tipped-off *Variety*.

R.M.A. last month renewed opposition to shows of receiving sets, trade or public, local or national, as "detrimental to the industry," and recommended manufacturers to support no shows, directly or indirectly, and to urge their jobbers not to participate.

"Decision of the radio networks to abolish line charges of \$1,200 a broadcast from the West Coast started a boom out here," Hollywood (ex-Broadway) Columnist Ed Sullivan wired the *New York News* last month: "It has assumed the proportions of the gold rush of '49. The swing is away from New York's Radio Row." New York studios denied (for publication) that

they are making wholesale clearances of personnel.

Tuning Eye inventor Allen B. DuMont of Montclair, last month announced removal to Passaic, N. J., to establish larger cathode-tube and oscilloscope factory; as this business is doubling yearly.

F.C.C., in extending allocations of wave-channels to 300,000 kc. last month, leaves only micro-waves, below 1 meter, for purely experimental purposes. "It means," vaticinated Dr. A. N. Goldsmith, "that radio research is going to concentrate on short distance development, from 20 to 30 miles." Backyards to conquer now, instead of worlds.

Camden has passed Philadelphia as a radio manufacturing district, R.M.A. analysis of radio tax returns showed last month; though Chicago is ahead of either, but not of both. About 56% of total national production is concentrated in the 3.

DEVELOPMENTS OF THE MONTH

SHORT-WAVE relay equipment, the value of which was proved in the flood emergencies of last year, was recommended as standard station equipment by the National Association of Broadcasters to its members at its recent convention.

NBC, opening its new studios in the Trans-Lux Building at Washington (D.C.), announced that the largest has been fully-equipped for television, when that is introduced to the nation's capital.

Super-power for short-wave stations will become a reality with the 100-kw. transmitter of W2XAD and W2XAF, Schenectady, authorized by the F.C.C. to the General Electric Co. last month.

In addition to fostering the sale of nearly a million radio sets last year, the German government stopped night life in Berlin one night last month, while all employees were called to listen in to an official "Labor Front" speech over hotel and restaurant radio receivers.

Television has come to Kansas City, where ultra-shortwave experimental transmissions are being made on 6 meters by station W9XBY.

RADIO PIONEER HONORED



In commemoration of the 25th anniversary (last August) of the Dubilier Condenser Company, Ltd., London, its board of directors paid tribute to its radio pioneer founder Mr. William Dubilier, by presenting him with a handsomely engraved scroll shown above. Mr. Dubilier founded both the British Dubilier and the American Dubilier Company, the latter of which is now known as the Cornell-Dubilier Electric Corporation.

Please Say That You Saw It in RADIO-CRAFT

The Best "BUYS" Are Made For Cash!



● It costs a distributor or a dealer at least 5% to sell and handle tubes on any of the "no investment" finance plans. You, the dealer, have to pay this 5% or more . . . The depression is over and depression methods of doing business are rapidly becoming obsolete. That is why increasing thousands of dealers and service men are saving money and getting the highest quality tube by buying RAYTHEONS on regular terms.



ASK YOUR RAYTHEON JOBBER



445 Lake Shore Drive, Chicago, Illinois
 555 Howard Street, San Francisco, Cal.
 420 Lexington Avenue, New York, N. Y.
 55 Chapel Street, Newton, Massachusetts
 415 Peachtree Street, N. E., Atlanta, Ga.



Quiet Your Razor to Quiet Your Radio!

Filternoys Suppressor F01DH is an approved plug-in device to be attached to any electric razor and plugged into the electric fixture. It takes the noise of an electric razor's motor out of your radio programs.

CONTINENTAL Filternoys F01DH, list price \$1.00, offers radio servicemen a handy profitable item to sell on many service calls. Carry a few in your kit. Any **CONTINENTAL CARBON** distributor can supply you.

CONTINENTAL CARBON Inc.

13914 LORAIN AVE., Cleveland, Ohio
 Also, Toronto, Canada
 Makers of Carbon Resistors, Paper Condensers, and Noise Suppression Filters
 Enclosed find 10c in coin or stamps for my copy of Handy Pocket Data on Radio Interference Elimination.

Name Address

City State

Short Wave Converters for Car Radios



Can be attached to any car radio, fits on and off switch and does not affect the reception on the standard broadcast band.
MODEL 600 covers 40-31-25-20-19 and 16 meter bands. Designed for American and Foreign short wave broadcast. Distance range 5000 to 10000 miles. Especially adapted for use in tropical countries as these bands are almost free from heat static. Now being used successfully in Canada, Alaska, Mexico, Panama, Colombia, Cuba, India, Indo-China, Netherlands and many other countries. List Price \$24.95

FIVE POLICE MODELS AVAILABLE UPON APPLICATION
 Jobbers and Dealers wanted

ABC RADIO LABORATORIES

3334 N. New Jersey St., Indianapolis, Indiana, U.S.A.



Universal Ribbon MICROPHONES

Self energizing. No polarizing voltage. Plug in and use. Distant pickup. Semi-directional. No feedback. Unconditionally guaranteed. Incl. ten feet 2-conductor cable. Can be used on amplifiers not less than 85 db. gain.

Microphone Division
UNIVERSAL MICROPHONE CO., LTD.
 424 Warren Lane,
 INGLEWOOD, CALIF., U.S.A.

LIST \$22.50 without plug
 LIST \$24.25 with plug

PHOTOELECTRIC CELLS

A prominent manufacturer has produced this cesium-oxide, 4-prong tube. Expertence and production methods assure you a tube of high sensitivity and dependability—maximum working voltage of 90.

Most efficient for use in electronic relays, controls, alarms, speed indicators, automatic counters, plus many other uses.

\$1.79 EACH

FREE! A postcard with your name and address brings our new, 32-page 1938 Catalog.

ARROW SALES CO.
 27 S. Jefferson St., Chicago, Ill.

HOW TO MAKE A 2-WAY "HAM" STATION FOR 5-METER PHONE

(Continued from page 408)

THE TRANSMITTER

The 6V6 Tri-Tet Oscillator-Doubler. The radio-frequency end of the transmitter is entirely conventional. A 6V6 tube (described in October *Radio-Craft*, pg. 204), the baby brother of the 6L6 beam power tube, is used as a standard tri-tet oscillator (as it is called); in this circuit the tube is also utilized as a regenerative frequency-doubler. The cathode circuit of the 6V6 tri-tet is tuned to some frequency only roughly double the crystal frequency (or until requisite regeneration is obtained); note that L1 then functions mainly as a choke coil—semi-aperiodic with respect to the fundamental, and most of the harmonic, frequencies of the crystal—and with C1 (and C) acting primarily as an R.F. bypass, and not as a circuit tuned sharply to the crystal fundamental or any of its harmonics. The plate circuit of the 6V6 is exactly resonated at 28 megacycles.

The 6N6 Regenerative Frequency-Doubler. The output from the 6V6 tube is then linked-coupled to the grid circuit of the 6N7 output tube which, also tuned to 28 megacycles, is operated as a second frequency-doubler; the plate circuit of the 6N7 therefore, by virtue of being tuned to double the input frequency, delivers energy at 56 megacycles. Referring to the schematic circuit, Fig. 1A, it will be seen that the 2 grids of the 6N6 tube are connected in push-pull and the plates in parallel. This plate circuit is then tuned to double the grid frequency or 56 megacycles.

Regenerative Doubler. In order to secure maximum output, regeneration is used in the doubler stage. The requisite feedback voltage is obtained through variable condenser C6. Increasing the capacity of the condenser will provide sufficient regeneration without introducing any tendency toward self-oscillation.

To tune-up the R.F. end of the transmitter a new, square, low-cost, 2-in.-size 100 ma. meter is used. It might be well to mention that without

a meter it is well nigh impossible to align the circuits. The meter is inserted first in the plate circuit of the 6L6 tri-tet tube, and L1 and L2 tuned simultaneously for minimum reading; and then, finally, the plate circuit of the 6N7 tube, and the output circuit tuned for maximum meter indication. A type of meter jack may be used which connects first one and then the other circuit as the plug is pressed still further into the jack.

The 6C8G Preamplifier. The modulator unit is exceptionally small when it is realized there is ample gain when operated with a low-level crystal microphone. This is accomplished through the use of the new twin-triode 6C8G tube (described in September *Radio-Craft*, pg. 146). The 6C8G tube, for its 2 triode sections in cascade, gives an approximate total gain of 1,500.

The 6L6 Modulator. The 6C8G is resistance-capacity coupled to the 6L6 tube operating in class A arrangement. While it may be possible to eliminate the 6C8G preamplifier and feed the 6L6 direct from a sensitive carbon microphone the inclusion of the 6C8G, together with a crystal microphone, eliminates batteries, microphone transformer and the resultant carbon hiss which, together with a loss in frequency response, is so prevalent in single-button microphones.

This transmitter when properly aligned will give a "clean", high-quality output of approximately 6 to 8 W.

While any type of antenna may be utilized, exceptionally good results were obtained with a "matched half-wave impedance" antenna. The telescopic feature of this unit (a commercial design of which is shown in Fig. 4A) makes it possible to adjust the antenna to a fraction of an inch. The diagram shown in Fig. 4B is for use with 6-in. spreaders.

In Fig. 1A, feed "B+1" with about 150 ma. at 300 V.; Fig. 1B, "B+2," 50 ma., 250 V.

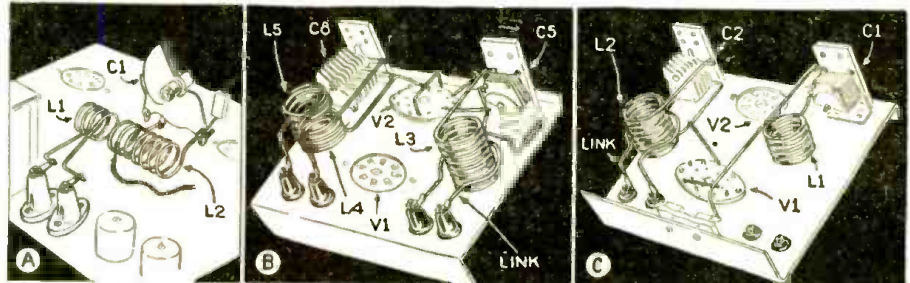

Fig. 2. The self-supporting coils may be purchased; or made at home (see List of Parts).

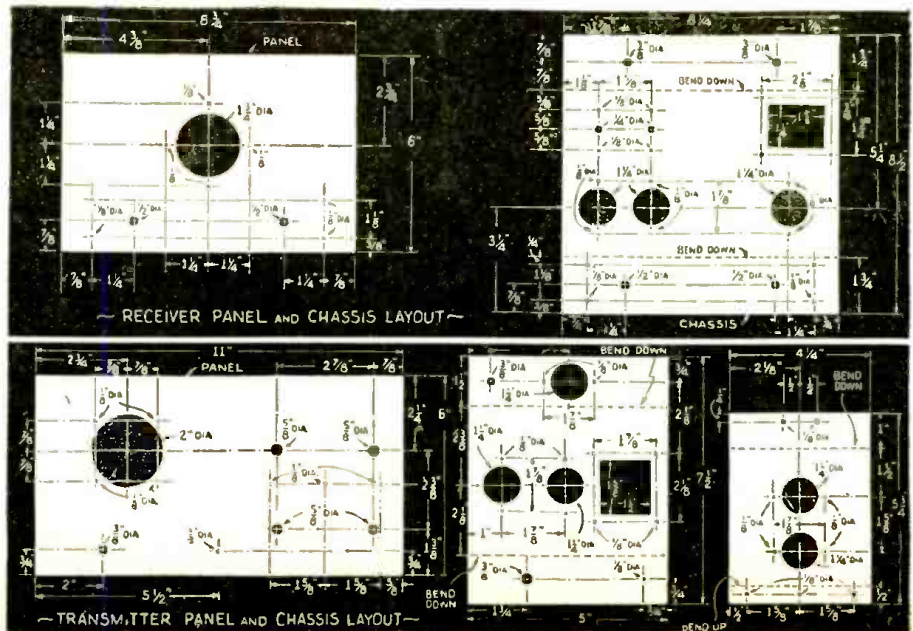

Fig. 3. The author used 1 chassis for the receiver; but 2 for the transmitter, and ceramic condenser-mountings (see Fig. 28 and C.)

Please Say That You Saw It in RADIO-CRAFT

THE RECEIVER

The receiver, which is shown in Figs. A, B and C, is a standard ultra-high-frequency super-regenerative set. While it is simple in design it is capable of excellent performance when properly constructed.

The 6K7 Electron-Coupled Super-Regenerative Detector. Tube V1, the 6K7 utilized for the detector, as shown in Fig. 1B, is of the electron-coupled type. That is, the screen-grid is grounded through condenser C5 which serves as, what may be considered as, the plate of a "grounded-plate oscillator."

The 6F6 Output Tube. The 6F6 metal output tube affords ample output for magnetic-type headphones. The output of this stage may be fed into a succeeding, higher-power stage, if it is desired to operate a loudspeaker, and the headphones allowed to remain in the plate circuit of the 6F6 in order to act as the plate load. The final stage then could conveniently be capacity-coupled to the plate of the 6F6.

The 6C5 Quench Oscillator. The 6C5 quench oscillator applies a quench voltage to the screen-grid of the detector tube; while the screen-grid bypass condenser, C5, serves also as the tuning condenser for the plate coil of the 6C5 tube. For the benefit of those unfamiliar with this type of circuit, the following outline—which, due to space limitations, is brief—will suffice.

HOW THE QUENCH OSCILLATOR FUNCTIONS

Super-regeneration is regeneration carried beyond the point of oscillation without distortion to the received signal. This is achieved by permitting the detector circuit to oscillate, then damping-out the oscillations, a great many times per second above the audible frequencies.

This type of detection is much more sensitive than the straight regenerative detector and is therefore extremely desirable for ultra-high-frequencies. Another advantage is that the sensitivity to strong signals is quite low. This action is very similar (but reciprocal) to A.V.C. and helps eliminate to a large extent automobile ignition and other man-made noises.

In order to keep the quench frequency from reaching the audio tube, V3, a tuned filter is included in the receiver which greatly improves the operation of the audio stage. The quench filter consists of L3 and C7, and is adjusted as follows:

Connect an output meter or a neon lamp to the audio output terminals and rotate condenser C6 for minimum output. (As the quench frequency is superaudible it is apparent that phones cannot be used for making this adjustment.)

Another important point is the connection of the quench oscillator coils. These coils are to be connected in reverse. That is, the coil marked "grid" is to be connected in the plate circuit, and the coil marked "plate" is to be connected in the grid circuit, of the 6C5.

DESIGN CONSIDERATIONS

Rigidity and compactness, with high-quality, low-loss insulation, together with correct arrangement of the components, are essential if duplication of these circuits and their effectiveness are desired. Perhaps the most important single factor is short plate and grid leads.

(Continued on page 441. List of Parts appears on page 438.)

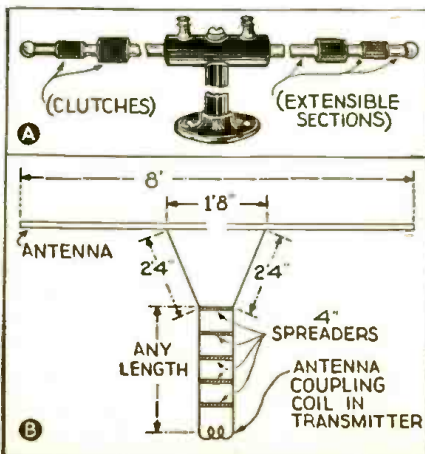

Fig. 4. A tunable dipole (A) is available on the market; dimensions and connections are shown at B.



"I'll show you how to get the jobs that other Radio men Can't handle"

MAKE \$40-\$60 a WEEK

with this
New Kind of Radio Training

It Actually Sets You Up for Business!

Now there's a new kind of Radio training every man should know about if he wants to get on the money end of the Radio Industry. Men taking my training right now are actually earning \$10, \$15, \$20 a week and more in spare time—while they learn. Men who have graduated are holding down jobs paying \$60 a week and up.

Make More Money Quick

My course is arranged so that you get practical lessons right at the start. Quickly, you are ready to begin servicing sets. Useful, simple job sheets show you every step to take. And you have the equipment to handle these jobs properly. Time and time again my students write in to tell me they are handling jobs other Radio men couldn't handle. That's because my easy-to-understand lessons and professional equipment make you a real Radio expert.

No Experience Needed

Old-timers and new comers are taking this new kind of training and making real money in Radio. If you are a Radio man now, you know now is the time to get extra training and bigger pay. If you are just about to enter Radio, now is the time to start taking this thorough, easily-learned course. Everything is clear. Everything practical. You learn business methods, gain self-confidence, get the satisfaction that nothing but quick cash in the pocket can give you.

Get the Facts

Mail the coupon at once for a FREE copy of "More Money in Radio," and also a FREE "BUSINESS BUILDER."

BIG OUTFIT SENT

As a regular part of my training I send you a Big Outfit, including Triplet Tester, complete set of Rider Manuals, Professional Tool Kit, Repair Parts, Work Sheets and Eby Electric Eye.

GET FREE BUSINESS BUILDER SERVICE MEN! NOTE

For you men already in the business I have my famous "Master Service Course" consisting of 45 important and practical lessons. Describes the actual how to do it. Practical, modern and easy to understand. Every service man needs this special course. Nothing like it in print. Represents years and years of experience at actual Radio Service work. The free book "More Money in Radio" tells about both courses. **TERMS AS LOW AS \$3 PER MONTH. UNION-CLAD. MONEY BACK AGREEMENT** fully protects you.



GET FREE BOOK
Mail Coupon Now

Sprayberry Academy of Radio,
F. L. Sprayberry, President,
120-A University Place, N.W.,
Washington, D. C.

Please send me a free copy of "More Money in Radio," and also a free "BUSINESS BUILDER."

Name Age

Address

City State

Paste coupon on penny postcard, mail TODAY.
If interested in Service Course only, check here ()



FREE

The Finest Radio Catalog ever printed . . .

Just off the press! Complete line of Sound Equipment . . . the latest and finest made. First Licensed Transmitter . . . built by the Hallicrafters and licensed by R. C. A. Newest and finest in "Ham" Receivers, parts and accessories. Everything for the Service Man, Amateur and Experimenter. All at rock bottom prices . . . all sold on Wards convenient Monthly Payment terms. Send for your copy today!

MONTGOMERY WARD · CHICAGO

- Sound Systems and Equipment
- Inter-Communication Systems
- Automobile Radios and Supplies
- "Ham" Transmitters and Parts
- "Ham" Receivers and Supplies
- Testing Instruments and Books
- Replacement Parts and Supplies

MONTGOMERY WARD, Dept. RZ-5, Chicago, Ill.

Send me my Free copy of Wards new 1938 Radio Catalog. I am particularly interested in the equipment checked at left.

Name

Address

City State

Please Say That You Saw It in RADIO-CRAFT



TRANSOIL

for transmitting
**HIGHEST QUALITY
OIL CAPACITORS**

Ask for new complete
Transmitting Catalog
describing

TRANSOIL—SOLAR—TRANSRICA

SOLAR MFG. CORP.  599 BROADWAY
NEW YORK CITY

PRICES REDUCED

on two Brush micro-
phones — BR2S and
B-1. If your jobber
can't supply you, write
us.

THE BRUSH DEVELOPMENT CO.
3312 Perkins Ave., Cleveland, Ohio

**AN IDEAL GIFT FOR XMAS
9-INCH WORKSHOP
SOUTH BEND LATHE**

New Low Terms
ONLY \$625
A MONTH

Give him a lathe for Xmas—The 9"x3" Workshop Precision Lathe—Back-Geared, screw-cutting. Made in 4 bed lengths. Takes 38 attachments. Wt. 320 lbs. Prompt deliveries for Xmas.

Write for Catalog 15-Y

\$90 LESS MOTOR DRIVE

SOUTH BEND LATHE WORKS
366 E. Madison St. South Bend, Ind., U.S.A.



**RADIO
ENGINEERING,**

broadcasting, aviation and police radio, servicing, marine radio telegraphy and telephony, Morse telegraphy and rail-way accounting taught thoroughly. Engineering course of nine months' duration equivalent to three years of college radio work. All expenses low. Catalog free. School established 1874.
Dodge's Institute, Hudson St., Valparaiso, Ind.

"DEPEND ON DEPENDABLE"
Before you buy any test equipment, write for new Catalog C.

RADIO CITY PRODUCTS CO.
88 PARK PLACE NEW YORK CITY

Post cards make it easy to answer advertisements which appear in *Radio-Craft*, without cutting valuable data which you may wish to save. Send for a supply of free post cards and use them in answering all *Radio-Craft* advertisers.

**HOW TO MAKE A
2-WAY "HAM" STATION
FOR 5-METER PHONE**

(Continued from preceding page)

LIST OF PARTS

Transmitter

- Six turns No. 14 wire, spaced-out to 3/4-in., L1;
- Nine turns No. 14 wire, spaced-out to 1 1/4 ins., L2;
- Nine turns No. 14 wire, spaced-out to 1 1/4 ins., L3;
- Four turns No. 14 wire, spaced-out to 3/4-in., L4;
- Three turns No. 14 wire, spaced-out to 1/2-in., L5;
- (All coils have an inside dia. 3/8-in.; they are spaced-out to the widths indicated above.)
- *One 2-in. meter, 100 ma.;
- One Solar mica condenser, 100 mmf., C;
- One Hammarlund midget condenser, 75 mmf., C1;
- Two Solar mica condensers, 0.001-mf., C2, C4;
- Two Hammarlund midget condensers, 35 mmf., C3, C5;
- One Hammarlund variable condenser, 100 mmf., C6;
- One Solar mica condenser, 500 mmf., C7;
- One Hammarlund variable condenser, 35 mmf., C8;
- Three Aerovox condensers, 0.01-mf., 450 V., C9, C12, C13;
- Two Cornell-Dubilier condensers, 1. mf., 200 V., C10, C11;
- One Cornell-Dubilier condenser, 10 mf., 50 V., C14;
- *Two condensers, 1. mf., 450 V., C15, C16;
- Two I.R.C. resistors, 50,000 ohms, 1 W., R1, R13;
- Two I.R.C. resistors, 25,000 ohms, 1 W., R2, R12;
- One I.R.C. resistor, 5,000 ohms, 1 W., R3;
- One I.R.C. resistor, 1 meg., 1/2-W., R4;
- One I.R.C. resistor, 1,000 ohms, 1/2-W., R5;
- One I.R.C. resistor, 1,500 ohms, 1/2-W., R6;
- One Centralab variable resistor, 0.5-meg., R7;
- Two I.R.C. resistors, 0.1-meg., 1/2-W., R8, R9;
- One I.R.C. resistor, 0.5-meg., 1 W., R10;
- One I.R.C. resistor, 300 ohms, 5 W., R11;
- One Kenyon modulation transformer, type 451, T;
- One meter jack (see text), J1, J2;
- One Lynch drilled chassis;
- One Raytheon type 6V6 tube, V1;
- One RCA Radiotron type 6N7 tube, V2;
- One Sylvania type 6CA6 tube, V3;
- One National Union type 6L6 tube, V4;
- *Four octal ceramic sockets.

Receiver

- Four turns No. 14 wire, spaced-out to 1/2-in., L1;
- Seven turns No. 14 wire, spaced-out to 1 in. and tapped at 3rd turn, L2;
- *One choke, 80 mhy., L3;
- *Two quench oscillator units, L4, L5;
- One Hammarlund variable condenser, 15 mmf., C1;
- One Solar mica condenser, 50 mmf., C2;
- Two Solar mica condensers, 0.001-mf., C3, C4;
- One Solar mica condenser, 0.002-mf., C5;
- One Hammarlund trimmer, 140 mmf., C6;
- One Solar mica condenser, 200 mmf., C7;
- Two Cornell-Dubilier paper condensers, 1 mf., 450 V., C8, C11;
- One Cornell-Dubilier paper condenser, 0.1-mf., 450 V., C9;
- One Cornell-Dubilier paper condenser, 0.01-mf., 450 V., C10;
- One Aerovox condenser, 10 mf., 50 V., C12;
- One Continental Carbon resistor, 3 meg., 1/2-W., R1;
- One Centralab potentiometer resistor, 50,000 ohms, R2;
- One Continental Carbon resistor, 1 meg., 1/2-W., R3;
- Two Continental Carbon resistors, 50,000 ohms, 1/2-W., R4, R7;
- One Continental Carbon resistor, 10,000 ohms, 2 W., R5;
- One Continental Carbon resistor, 500 ohms, 2 W., R6;
- One Centralab potentiometer, 0.5-meg., R7;
- One Kenyon audio choke, type T155, Ch.;
- One drilled chassis;
- One National Union type 6K7 tube, V1;
- One National Union type 6F6 tube, V2;
- One National Union type 6C5 tube, V3;
- *One telescope antenna, 4-in. spreaders;
- *Three octal ceramic sockets.
- *Most Radio mail order houses can supply these items if properly identified as to title of article, issue (month) of *Radio-Craft* and year.

Astounding
but it is a fact!
**The GERNSBACK
OFFICIAL RADIO
SERVICE MANUALS**
(Volume 1 through 6)
Contain Over 13,000
Service Diagrams

IN 1931 the first Gernsback OFFICIAL RADIO SERVICE MANUAL was published—each successive year a new volume appeared. Today over 87,000 OFFICIAL RADIO SERVICE MANUALS are being constantly used by radio Service Men.

Every edition of the Manual is an encyclopedia of schematic diagrams. The first six volumes contain over 13,000 wiring diagrams. Rarely comes a set for servicing for which you can't find the diagram and service information you need. Diagrams for sets which were distributed in 1927—and many marketed prior to that date—are published in Gernsback Manuals.

Here is a complete listing of all the Gernsback OFFICIAL RADIO SERVICE MANUALS, including the two volumes of the OFFICIAL AUTO-RADIO SERVICE MANUALS.

Over 1,200 Pages—Over 2,500 Illustrations—\$7.00	1936 MANUAL
Over 1,000 Pages—Over 3,000 Illustrations—\$7.00	1935 MANUAL
Over 400 Pages—Over 2,000 Illustrations—\$3.50	1934 MANUAL
Over 700 Pages—Over 2,000 Illustrations—\$5.00	1933 MANUAL
Over 1,000 Pages—Over 2,000 Illustrations—\$5.00	1932 MANUAL
Over 650 Pages—Over 1,500 Illustrations—\$4.50	1931 MANUAL
Over 240 Pages—Over 500 Illustrations—\$2.50	1933 AUTO-MANUAL
Over 240 Pages—Over 500 Illustrations—\$2.50	1935 AUTO-MANUAL

Any of these Manuals can be ordered by filling in coupon below and mailing it with your remittance to RADCRAFT PUBLICATIONS, Inc., 99 Hudson Street, New York, N. Y.



MAIL COUPON TODAY!

RADCRAFT PUBLICATIONS, Inc. RC-138
99 Hudson St., New York, N. Y.

Gentlemen: Enclosed find my remittance of \$... for which send me **POSTPAID** One Copy of the **OFFICIAL RADIO SERVICE MANUAL**. (Send remittance by check or money order. Register letter if you send cash.) This offer is good only in U. S.

Name

Address

City State

Please Say That You Saw It in RADIO-CRAFT

NO REASON YOU SHOULDN'T PROFIT FROM SERVICING TIPS FEATURED IN BERNSELY'S Official Radio Service Handbook

PROFESSIONAL men like to learn new things about their business—and we've found that radio men are wise to the "tricks" also. That is why thousands of radio service men constantly refer to Bernsley's OFFICIAL RADIO SERVICE HANDBOOK. It has the servicing tips your business requires—and many more besides. The HANDBOOK is the "by word" among crackerjack radio men.

HERE ARE THE OUTSTANDING FEATURES

Special section exceeding 250 pages of Operating Notes for Standard Receivers • Circuit Theory and Analysis • Servicing Equipment • Standard and Specialized Receiver Installations • Modernization and Conversion Data • Social and Economic Problems of the Service Man. In all there are over six hundred topics covered—with illustrations and photographs aplenty.

It's a text book every radio Service Man needs—It's a comprehensive volume of

Over 1,000 Pages
Over 1,000 Illustrations

It is sturdily bound to assure tough usage—and it has an attractive, stiff linen cover with title stamped in gold letters. Conveniently sized—6 x 9 inches—and weighs over two pounds.

RADCRAFT PUBLICATIONS, Incorporated
99 Hudson St.
New York, N. Y.



RADCRAFT PUBLICATIONS, Inc. RC-138
99 Hudson St., New York, N. Y.

Gentlemen: Please send me on FIVE-DAY APPROVAL One Copy of BERNSELY'S OFFICIAL RADIO SERVICE HANDBOOK. If I retain the book, I will remit promptly the amount of \$4.90. Should I return the book, I pay only the mailing costs to you.

Name

Address

City State

Employed by

(This offer is good only in U.S.A.)

FACTORY TO YOU
NEW REMINGTON NOISELESS PORTABLE!



10¢ A DAY

Famous Remington Noiseless Portable that speaks in a whisper, only 10¢ a day, direct from factory. Standard keyboard. Automatic ribbon reverse. Variable line spacer and all the conveniences of the finest portable ever built. PLUS the NOISELESS feature. Act now. Send coupon TODAY for details.

You don't RISK a Penny

We send you Remington Noiseless Portable for 10 days' free trial. If not satisfied, send it back. We pay all shipping charges.

FREE Typing Course and Carrying Case

You will receive FREE a complete simplified home course in Touch Typing. Also FREE, a handsome, sturdy carrying case. No obligation. Mail coupon for full details—NOW

Remington Rand Inc., Dept. 189-1
465 Washington St., Buffalo, N. Y.

Tell me, without obligation, how to get a new Remington Noiseless Portable, plus Free Typing Course and Carrying Case, for 10¢ a day. Send Catalogue.

Name

Address

City State

BE SURE YOUR NEWSDEALER RESERVES MARCH 1938 RADIO-CRAFT FOR YOU.

TELEVISION STUDENTS LEARN BY MAKING CATHODE-RAY TUBES

(Continued from page 403)

and the lower neck. The graphite is obtained in colloidal form (that is, fine particles of graphite suspended in water) and is known commercially as "Aquadag."

In cathode-ray tube manufacture, aquadag is usually mixed with two or three times its volume of distilled water and the resulting solution carefully worked and agitated to effect a homogeneous dispersion of the graphite. In simpler words, there must be no lumps, no matter how small, in the solution.

Numerous methods for applying the graphite coating were tried until the ultimate one, to be described, was evolved. Although these experiments were numerous, time-consuming and oftentimes disastrous to our clothes, we obtained a considerable amount of valuable information from them.

HEATING THE AIR INSIDE THE C.-R. TUBE

We found, for instance, that the air inside the cathode-ray tube had to be heated before the graphite would adhere to the sides of the tube. Experimentation with the proper method for heating this air eventually resulted in the method shown diagrammatically in Fig. 1, and photographically in Fig. F.

The early experiments were so disappointing that at one time we were almost tempted to use an internal coating of metal like potassium and magnesium instead of graphite. These metals, however, have a tendency of combining only with the active gases which remain in a tube after it is evacuated and not with the inert gases which, therefore, tend to reduce the high vacuum necessary for proper operation of the cathode-ray tube.

Graphite, on the other hand, possesses the highly desirable power of adsorption; that is, it has an affinity for all types of gas molecules, which adhere to its surface but do not combine with the graphite chemically. Thus, any gases remaining in the tube after evacuation are adsorbed by the graphite, thereby maintaining the high vacuum within the tube.

With this and other points in its favor, we determined to find a solution for the method of applying the graphite coating. Figure F shows the apparatus which we used and with which we were finally successful.

APPLYING THE GRAPHITE

As shown (diagrammatically in Fig. 1), the aquadag solution is contained in a metal funnel, through the center of which extend 2 concentric glass tubes, one being the hot-air intake and the other the exhaust tube. Then we lowered the cathode-ray "blank" into the liquid by means of the pulley system shown. It was necessary to place a fingered guide over the exhaust tube since otherwise the cathode-ray blank would be

(Continued on following page)

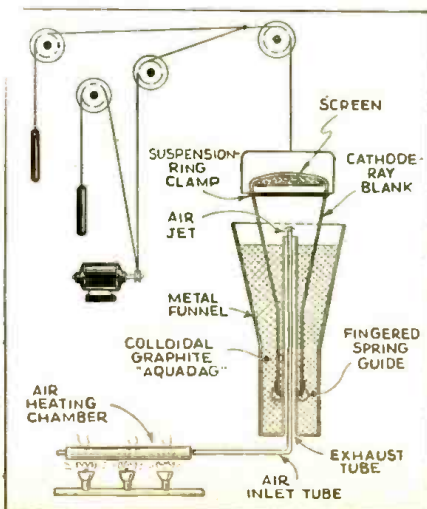
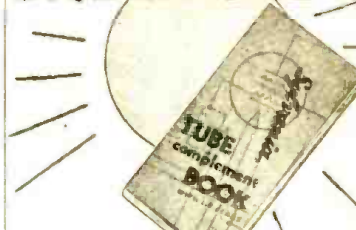

Fig. 1. Diagrammatic view of the set-up for graphite-coating the inner surface of the tube.

Please Say That You Saw It in RADIO-CRAFT

SOMETHING NEW UNDER THE SUN



A COMPLETE TUBE COMPLEMENT BOOK

Of course there have been tube complement books before. But when you find one as full of helpful information as is the big,

200 page Sylvania Tube Complement Book

—that's something new.

Take a look at this list of features:

- 1 • Tube complement listings for 10,386 models.
- 2 • Listings for 259 companies.
- 3 • Most complete compilation of i-f peaks available.
- 4 • Contains helpful articles on tube selling, etc.
- 5 • Largest compilation of trade names ever made—560 names.

That's all we have room to mention here. But there are many more features—all designed to be of help to you.

Where "under the sun" can you find a book as complete as this one? And the price is only a quarter!

See your jobber, or send the coupon below and 25c to us. You'll get your copy of the Sylvania Tube Complement Book in a few days.

SYLVANIA
Set-Tested Radio Tubes

HYGRADE SYLVANIA CORPORATION
Emporium, Pa. RC-19

Enclosed please find 25c. Send me my copy of your new Tube Complement Book right away.

Name

Address

City State

Dealer Service Man

Amateur Experimenter



E. H. RIETZKE PRES. OF CREI

INSURE YOUR FUTURE!
Start Training Now in
**PRACTICAL RADIO
ENGINEERING**

Do you ever sit down and "look your job in the face"? Are you satisfied with your present position, or anxious to get ahead? Today, you can't be satisfied, because rapid new developments mean Radio wants only men who are **TECHNICALLY TRAINED.**

GOOD Men in Radio—Have GOOD Jobs
But, you need something more than "good intentions." Right now is the time to start training—so you won't be left behind when others go ahead. CREI offers you home-training that will equip you to keep pace with Radio.

Read this FREE Book
"A TESTED PLAN FOR A FUTURE IN RADIO"

Just off the press! 48 pages of interesting facts and illustrations. Describes CREI courses and your future in Radio. **WRITE FOR YOUR COPY TODAY!**

**CAPITOL RADIO
ENGINEERING INSTITUTE**
Dept. RC-1
14th and Park Rd., Washington, D.C.
New York City—29 Broadway

DON'T!
**BUY ANY AMPLIFIER OR
PUBLIC ADDRESS SYSTEM**
until you read our bulletin describing a new line of 1938 amplifiers designed by A. C. Shaney featuring:
Audio Spectrum Control
Cathode-Drive Amplification
Automatic Feedback Suppression
F.V.F.B. Beam Power Amplification
Automatic Audio Volume Control
Floating Audio Power
Plus many other exclusive features.
Our Amazingly Low Prices, Free Trial Offer, and Usual Five Year Guarantee Make it Well Worth Your While to Write To-Day for Free Bulletin No. PA 138. Free P.A. Consulting Service.

AMPLIFIER CO. OF AMERICA
37-47 West 20th St., New York, N. Y.

Better - Quicker - More Profitable Servicing with RADIO CHASSIS CRADLE



Service shops need the **RADIO CHASSIS CRADLE** for efficient servicing of testing and repairing of receivers or amplifiers. Equipment clamps to cradle which can be adjusted to any angle. Accommodates chassis up to 13 x 12 x 23 inches. Excellent for displaying receivers. Write for illustrated circular KCI

WM. A. THOMAS CO. 321 CAROLINE ST., NEENAH, WISCONSIN

MODERNIZE YOUR OBSOLETE TUBE CHECKER OR SET ANALYZER with "PRECISION"

Write for details. Mention make and model number of your old instrument.

PRECISION APPARATUS CORP.
1821 EAST NEW YORK AVE., BROOKLYN, N. Y.



SAVE UP TO 50%
1938 Models Latest Features
MONEY BACK GUARANTEE
Free Catalog
Zephyr Radio Co.
13141 Hamilton Blvd.
Detroit, Michigan

Be sure to turn to page 388 and read the important announcement which you find there.

(Continued from preceding page)

apt to lean to one side or the other and not become evenly coated on the inside of the narrow neck. Of course the outside of the bulb became coated, too, and had to be washed. Each bulb required 2 or 3 coatings.

A time-driven device to slowly raise the blank out of the aquadag was necessary to insure a uniform coating. A series of pulleys and a motor with a speed reducer were used in combination with a string and weight. A switch attached to the string was employed to automatically shut off the motor at the proper time.

Making an electrical contact through the glass wall of the vessel was another problem, since a large surface and a good contact were necessary for the thin coating of graphite. A piece of platinum foil fastened to a little tungsten and nickel hook was employed. When the glass was heated and the platinum pressed against it, it adhered to the "wet" glass. Since the platinum was so thin, it did not have strength enough to crack the glass due to the different coefficients of expansion between the pyrex glass and the platinum. This operation, naturally, had to be done before the graphite coating was applied.

In a cathode-ray tube, any 2 electrodes of different size with a difference of potential between them act as focusing electrodes. It is possible with certain types of electron guns to make the last electrode in the gun the same potential as the aquadag coating, with the result that the aquadag produces a negative focusing effect, and in that case, would act as a means of discharging the accumulated electrons. The aquadag coating may be used as a focusing electrode discharger or as a discharger only, depending upon its relation to the other gun design and assembly, and the potentials thereon. In our cathode-ray tube, it is used as a combination discharger and focusing electrode.

Part IV will continue this enlightening discussion with details on the design of the "electron gun" of the cathode-ray tube.

This article has been prepared from data supplied by courtesy of American Television Institute.

ORSMA MEMBERS' FORUM

(Continued from page 420)

to the owner because he was unable to fix it, and "believe it or not," all it needed was a ballast, and all new tubes. SO WHAT!

So I think that before fellows like Mr. Buchanan and others start throwing bricks at us new men, they had better clean their own house first.

M. MARTINEZ,
Los Angeles, Calif.

CONTRA: NRSA

RADIO-CRAFT, ORSMA Dept.:

I have read the protest of the National Radio Service Association concerning the "Radio Manufacturers Service" on page 505 of the Feb. 1936 issue of *Radio-Craft*. As member 16085 of the R.M.S. I would like to express my views.

The Philco Radio Corp. to my mind is doing more than anyone else in the industry at the present time to improve the status of the average Service Man. Before a man is accepted he has to furnish evidence of certain qualifications, and on approval the member is furnished with the usual cards of identity. Also he is given a scale of charges which would enable a man to make a decent living, were it not for the "Gyp and Screwdriver" expert that we all have to contend with no matter where we may be. But these fellows will eventually go down into oblivion like the racketeer. There are absolutely no strings attached to the membership, and a man can go his way servicing Philco or any other set that he wishes without any contracts or agreements of any description.

Further, the periodical issuance of very instructive literature by Mr. G. J. Irwin, their Chief Engineer, gives one the idea that the Philco people are very much alive to the chaotic conditions that existed (and still do) in the industry.

Until some other proposition is put forth that is as reasonable and less expensive than the above plan, I for one will certainly stick by Philco. Here's many thanks to them and may their campaign for better servicing and better conditions continue.

FRANK H. HAYDEN,
Essex, Ontario.

*Ask the Radio Man
Where He "Learned"
the "What's What"
About Test Equip-
ment, Tubes, P. A.,
Home Recording and
other Radio Subjects*

**THE ANSWER—
The RADIO-CRAFT
LIBRARY SERIES**

The RADIO-CRAFT LIBRARY SERIES has been the foundation for instruction for thousands in radio—in one or more of its specialized branches. For P.A. there's a book—for Auto Radio Servicing there's another—for Home Recording there's also a valuable text—for Theory of Vacuum Tubes—for Specialized Diagrams—for Servicing Various Receivers—for Test Equipment—and other subjects—each has a special volume.

Radio's most noted writers—Clifford E. Denton, Louis Martin, Robert Hertzberg, R. D. Washburne, Joseph T. Bernsley and others are the authors of books in the LIBRARY SERIES.

Each book contains 64 pages—measures 6 x 9 inches. The number of illustrations in the books vary from 50 to 120. Each volume sturdily bound with flexible cover. BOOKS ARE UNIFORM.

Here are the titles:

2. MODERN VACUUM TUBES.
3. THE SUPERHETERODYNE BOOK.
5. HOW TO BECOME A SERVICE MAN.
6. BRINGING ELECTRIC SETS UP TO DATE.
8. RADIO QUESTIONS AND ANSWERS.
9. AUTOMOBILE RADIO AND SERVICING.
10. HOME RECORDING AND ALL ABOUT IT.
12. PUBLIC ADDRESS INSTALLATION AND SERVICE.
13. ABC OF AIR CONDITIONING.
14. POCKET RADID GUIDE.
15. ABC OF REFRIGERATION.
17. SERVICING WITH SET ANALYZERS.

To order any one or more of the volumes in the 50c RADIO-CRAFT Library Series—clip—fill—and mail coupon below, with remittance, to RAD-CRAFT PUBLICATIONS, Inc., 99 Hudson Street, New York, N. Y.



MAIL COUPON TODAY!

RAD-CRAFT PUBLICATIONS, INC. RC-138
99 Hudson St., New York, N. Y.

Gentlemen: I have circled below the numbers corresponding to the titles in the RADIO-CRAFT Library Series. My remittance for the amount of \$ _____ is enclosed.

2 3 5 6 8 9 10 12 13 14 15 17

Name

Address

City State

Books sent PREPAID in U.S.A. only.

Please Say That You Saw It in RADIO-CRAFT

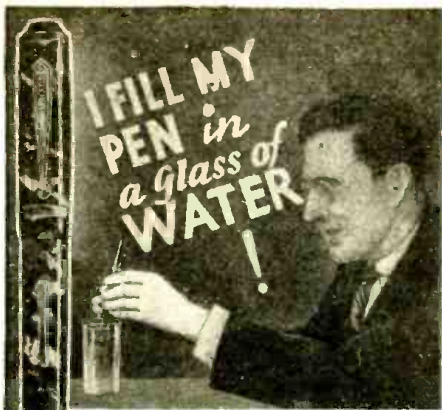

... Men!
HERE IS THE MODERN MIRACLE WATER PEN —

WHEREVER there's water, there's ink—for the MIRACLE WATER PEN. There's a tiny ink cartridge in the barrel of the pen—two or three lifts of the suction lever and the pen is completely filled. One small ink cartridge keeps this modern pen supplied with ink for many months.

All parts of MIRACLE WATER PEN are acid "corrosion" proof. Nibs are 14-karat gold-plated. Airtight inner cap keeps pen moist at all times. The ordinary fluid capacity is almost twice other pens. Five additional ink cartridges are carefully hidden in a reserve chamber. MIRACLE WATER PENS carry a life-time guarantee.

Order your MIRACLE WATER PEN today — by mail. Sent POST-PAID anywhere upon receipt of check, money order or cash for \$1.50. Regular \$4.00 value.



GREN PARK COMPANY
1229 Park Row Bldg., New York, N. Y.

GREN PARK COMPANY RC-138
1229 Park Row Bldg., New York, N. Y.
Gentlemen: Enclosed you will find my remittance of \$..... for which send me..... MIRACLE WATER PENS at One Dollar and Fifty Cents. (\$1.50) each. YOU ARE TO SEND ME THE PEN POSTAGE PREPAID. (In U.S.A. only.)

Name

Address

City State

(Send remittance by check, money order, unused U. S. Postage Stamps. Register letter if you send cash with order.)

SERVICING Q. & A.

(Continued from page 407)

One was a model 37-33 and the other a model 37-38. Both will operate when first turned on and operate OK, but when warm, if the receivers are turned off and back again, inoperation will result. Have tried new sets of tubes with no success. The model 38 is a 2-band receiver and operates on the short-wave band with no symptoms such as described. This trouble has been puzzling practically every Service Man in this locality. Please advise me where to look for the trouble. Both switches are OK.

(A.) From all appearances, the difficulty with the receivers in your inquiry is due to grid blocking. When ganged switches, in a battery receiver, such as shown in Fig. Q.38C, are opened and then closed before the tubes cool completely, charging current from the "B" battery through the plate resistor, coupling condenser and grid resistor causes the grid to become positive by an amount equal to the voltage drop across the grid resistor. It is possible that the grid becomes highly positive because of the heating lag of the filament. Under these conditions the grid may emit secondary electrons and since the secondary emission current flow is in the same direction as the charging current, the positive potential on the grid becomes very high. The transconductance and consequently the output of the tube is very low. When the receiver is turned off, sufficient time for the filaments to cool completely should be permitted before turning the switch "on" again.

One remedy is to connect the "B" switch in such manner that the "B" battery potential is placed upon V1 at all times to prevent charging current from flowing through the coupling condenser when the switch is closed. See Fig. Q.38C.

In some cases, lower values of both coupling condenser and grid resistor have effected a repair. This, of course, will affect both gain and frequency response.

"HAM" SET USES NEW TUNED-CRYSTAL FILTER CIRCUIT

(Continued from page 403)

greatly to improve operation of the phasing control.

This phasing condenser is of the differential type. By shaping the plates it was found possible to considerably reduce an interlocking action traceable to this factor.

Note that these characteristics now make it possible to leave the crystal in circuit at all times.

Our Information Bureau will gladly supply manufacturers' names and addresses of any items mentioned in RADIO-CRAFT. Please enclose a stamped and self-addressed envelope.

HOW TO MAKE A 2-WAY "HAM" STATION FOR 5-METER PHONE

(Continued from page 437)

The leads for the radio-frequency section of both the receiver and transmitter are kept extremely short due to the unique method of construction. It should be noted that the tanks (tuning coil and condenser sections) of the oscillator section of the transmitter are mounted quite close to the tube socket; and that the doubler tube is inverted so that the leads to the grid and plate tuning condensers are kept exceptionally short. We repeat: keep these leads short if proper operation is expected.

Chassis details of the receiver and transmitter are given in Fig. 3. Coils for both the transmitter and the receiver may be constructed in accordance with Fig. 2, and the data given in the List of Parts. The transmitter and receiver may be powered from batteries or a power pack as convenience dictates. Requisite voltages and current values are indicated in the diagram caption. (The receiver may be considered as a 5.5 to 2.5 meter receiver since the tuning range, without changing coils, extends to the higher frequency. To operate the transmitter on 2 1/2 meters, though, would necessitate adding 2 triode acorns in push-pull arrangement.) The writer will be glad to advise constructors who encounter any difficulty in building this 2-way, 5-meter "station."

THE Top-Notch REPLACEMENT TRANSFORMER



is PRICED with the LOWEST

You need never scratch your head again about which transformer to use. It's so easy to get the finest transformer your money will buy. Just say "UTAH" to your jobber. It took 16 years to evolve UTAH'S greater magnetic field efficiency, bigger safety factors, positive humidity seal and lower eddy current losses. Your low price is the result of enthusiastic popularity with manufacturers, amateurs and servicemen everywhere!

You're way ahead every time you replace with UTAH—the transformers that last longer, work better, but cost no more.



See your jobber or write Dept. RC-1 for catalog.

UTAH RADIO PRODUCTS CO.
CHICAGO, U. S. A.

TORONTO ONTARIO, CANADA BUENOS AIRES (UCOA RADIO PRODUCTS CO.)

"16 YEARS OF LEADERSHIP"

LEARN AT HOME — ONLY \$1 A MO.
RADIO ELECTRICAL ENGINEERING

RADIO ENGINEERING Extra Fine course in Radio, Public Address, Photo-Electric Work. Train yourself to be super-service man, real vacuum tube technician. Unusually thorough for the very low price!

ELECTRICAL ENGINEERING Get good grasp of wide electrical field. Simplified. Quickly understood.

ONLY \$25! Either course. Deferred payment plan. Experimental kits furnished. Diploma given on completion.

FREE! Send quick for free copies of school catalogs, student magazine, complete details. Don't enroll anywhere before seeing our literature. **WRITE NOW!**

LINCOLN ENGINEERING SCHOOL, Box 931-58, Lincoln, Nebr.



"HAM" SPECIAL Standard Teleplex

A highly efficient code teacher using heavy specially prepared waxed paper tape, having two rows of perforations. Write for Free folder A-1. We are the originators of this type instrument

Instrument with tapes prepared by expert and complete course; all for \$11.95. Without Oscillator. 72-76 Cortland St., N. Y. C.

TELEPLEX CO.

Please Say That You Saw It in RADIO-CRAFT

AS **NEW** TODAY
AS TOMORROW'S NEWS:

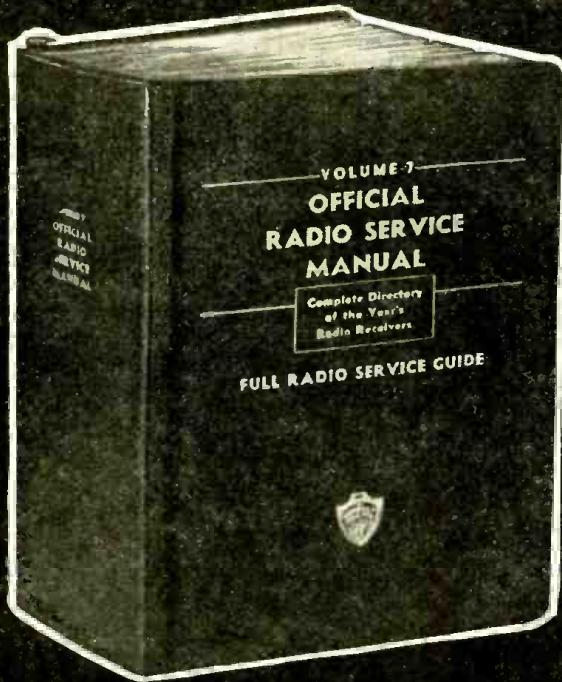

VOLUME 7
OFFICIAL RADIO SERVICE MANUAL

OVER
1,800
PAGES
★
OVER
3,000
ILLUSTRATIONS
★
SIZE: 9" x 12"

COMPARE other service manuals with the new GERNSBACK OFFICIAL RADIO SERVICE MANUAL (Volume 7) as it is published today. You'll find the GERNSBACK MANUAL, by far more complete in service information — more up-to-the-minute with present-day receiver diagrams — and published entirely differently than in previous years.

Most important of many innovations are the month-to-month installment method of publishing Volume 7 — and the deferred payment plan which makes it convenient for every Service Man to own radio's *greatest of service manuals*.

Write today for descriptive literature which gives complete information about Volume 7 of the OFFICIAL RADIO SERVICE MANUAL — and the plan which tells how to pay-as-you-compile your Manual. *Mail the coupon below — TODAY!*

RADCRAFT PUBLICATIONS, Inc.
99 HUDSON ST., NEW YORK, N. Y.

RADCRAFT PUBLICATIONS, Inc., 99 Hudson Street, New York, N. Y.

RC-138

Gentlemen: Please send me descriptive literature on Volume 7 of the GERNSBACK OFFICIAL RADIO SERVICE MANUAL — and details for buying this edition on the deferred payment plan.

Name

Address

City State

BUSINESS PROBLEMS OF THE SERVICE MAN

(Continued from page 414)

extended about 6 feet from and at right-angles to the wall. In back of the counter were some shelves on which there were about 90 to 100 tubes. A small aisle separated the counter from a partition in back of the store. In the middle of the partition an open door allowed a view of the workshop and bench. An analyzer was visible, no other test equipment was noticeable. The diagram (Fig. 1) will give a clearer picture of the layout.

SUMMARIZING

The radio sets were old models, the tubes were of various manufacture and not in sealed cartons. The analyzer must have been at least 6 or 7 years old. As far as I could determine from appearances, the maximum value of the store including fixtures, could not possibly exceed \$300.

Expressing this opinion to Mr. Degam, he informed me that according to Mr. W.'s inventory the list value of the merchandise was over \$750. The trade discount brought this value to a little less than \$450. The goodwill and customers' telephone list made up the difference. An advantage not mentioned heretofore was that the rent was only \$40 a month.

The highlights in this month's "Business Problems of the Service Man" are as follows:

- (1) Mr. Degam was anxious to open a radio store under most favorable conditions.
- (2) He was offered a going business at a bargain price—\$500.
- (3) The overhead was low.
- (4) He had an accumulation of equipment and parts with which to fill up the store.
- (5) He had a large passing crowd, a hospital and an elementary school in the immediate vicinity.

Under these circumstances, would you be inclined to buy the store described in this article?

- Now—my diagnosis:
- (1) The neighborhood was not thickly populated.
 - (2) Heavy pedestrian traffic means very little if it is only a crowd rushing to and from work.
 - (3) The number of empty stores was an indication that the shopping on that street was not heavy.
 - (4) Obsolete, low-priced radio sets; as well as an old stock of tubes, meant that his turnover was very poor.
 - (5) The value of the merchandise was over estimated. Standard trade discounts do not apply to obsolete merchandise.
 - (6) Goodwill and telephone call lists are of doubtful value unless the organization has been highly advertised or established in the neighborhood over a number of years.
- The above disadvantages overcame by far the advantages of the advertising value of a school and possible small set rentals in the hospital.
- The advice under these circumstances was—*don't buy!* Experience has since proven the worth of this suggestion.

RADIO WITTIQUIZ

(Continued from page 420)

detecting power losses in transmission lines. (c) One that will not overload with large R.F. signal and which delivers considerable power. (d) A service instrument used in detecting power of radio sets (direct reading scale). (e) One so designed as to deliver large power with a grid voltage of only 0.00025-millivolt, and plate voltage of +4½.

GEO. A. BOYOG

- (51) A variable resistor is—
- (a) The part of the tuning system of a radio receiver which rejects the unwanted stations.
 - (b) A resistor which varies from its rated value.
 - (c) A resistor having one or more sliding contacts for varying the amount of resistance included in the circuit.
 - (d) The valve which controls the grid-leak.

CARL F. COMNICK

(Continued on page 443)

\$1 PERSONAL STATIONERY



ALL letterheads are beautifully printed on the best Ivory or Grey Vellum paper, with your name and address printed in a choice of BLUE, BLACK or BROWN ink.

OFFER NO. 1 200 Club Size sheets, 6 3/4" x 5 3/4", plus 100 envelopes. Both printed handsomely with name, address, city and state. Envelop printed with address on back.

OFFER NO. 2 100 University Size folded sheets, 9 1/2" x 6 1/4", plus 100 envelopes. Both handsomely printed with name, address, city and state in any color ink. Envelop printed with address on back.

OFFER NO. 3 75 Monarch Size sheets, 10 1/2" x 7 1/4", plus 75 envelopes. Both printed with name, address, city and state. Envelop printed with address on back. Ideal for business or professional use.

Price for any one of the above three letterheads, including envelopes is only \$1.00. Shipment made within five days. Order today—enclose \$1.00 in cash, money order or unused U. S. Postage Stamps, add 15c postage for mailing. MONEY BACK GUARANTEE if not satisfied. Order by number and state color of paper, also ink color. BE SURE TO PRINT YOUR NAME, ADDRESS, CITY AND STATE to assure accuracy.

PRIVATE STATIONERY COMPANY

Department RC-138

246 FIFTH AVENUE NEW YORK, N. Y.

PYRO PANTAGRAPH

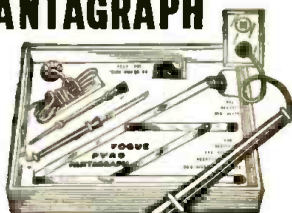

\$2.75

Shipping Wt. 3 lbs.

THIS electrical outfit is especially designed for burning designs permanently on materials such as Leather, Wood, Cork, Bakelite, etc.

Plug the Pyro-electric pencil in any 110 volt AC or DC outlet and it is ready to be used. Plug and cord furnished.

By the use of the Pantagraph included in the outfit, any design may be reproduced either in original, reduced or enlarged form.

Outfit consists of: one Pyro-electric Pencil; one Pantagraph; three hardwood plaques; one bottle of Varnish; one Brush; one tracing tip and four-page instruction sheet.

Size of box: 12 1/2 x 8 1/2 inches.

Outfit will be forwarded by Express Collect if not sufficient postage included with your order.

WELLWORTH TRADING CO.

558 W. Washington Blvd., Dept. RC-138, Chicago, Ill.

ELEMENTARY MATHEMATICS

For the Technician and Craftsman

CONTENTS OF BOOK

I. ARITHMETIC: Addition, Multiplication, Division. II. Factoring and Cancellation, Fractions, Decimals, Percentages, Ratio and Proportions. III. The Metric System. IV. How to Measure Surfaces and Capacities (Geometry). V. Powers and Involutions—Roots and Evolution. VI. Mathematics for the Manual and Technical Craftsman. Thermometer Conversions, Graphs or Curve-Plotting, Logarithms, Use of the Slide-Rule. VII. Special Mathematics for the Radio Technician. VIII. Commercial Calculations. Short-cut Arithmetic, Interest, Discounts. IX. Weights and Measures, Useful Tables.

50c
Postpaid

TECHNIFAX

Division RC-138

558 W. WASHINGTON BLVD. CHICAGO, ILLINOIS.

THE LATEST RADIO EQUIPMENT

(Continued from page 416)

GLASS-DIELECTRIC HIGH-VOLTAGE CONDENSERS (1513)

DESIGNED to afford low-loss and large safety factors at high voltages these new condensers have special appeal for sound and television experimenters. Available in 4 types—1 unmounted and 3 with white porcelain case (illustrated)—and capacities from 50 mmf. to 0.002-mf.; and voltage ratings from 2,500 to 7,500.

25-W. C.W. TRANSMITTER KIT (1514)
(Utah Radio Products Co.)

SHORT-WAVE amateurs will be interested in this new transmitter kit with its professionally-styled, ventilated cabinet. Unit features crystal control, new type 6L6 harmonic oscillator, all-band performance on only 2 crystals, self-contained power supply, antenna tuning condensers, and only one coil change per band. Utilizes one 6L6G and one 5Z4. Case measures 12 x 7 x 11 1/4 ins. high; black-crystalline finish.

NEW 16-IN. RECORDING AND PLAYBACK SYSTEM (1515)

THIS RECORDING system incorporates amplifier and recorder as separate assemblies.

Amplifier is equipped with duo input for 2 microphones, plus 500-ohm channel for line or radio input. Includes requisite switching facilities for continuous recording on 2 turntables; has volume level indicator and self-contained loudspeaker.

Recorder cuts and plays back any type of disc including master blanks for processing. Cutting and playback pressures are adjustable. Cutting head of electrostatic type is said to operate at constant amplitude below 250 cycles; and constant velocity, above. Cuts standard pitches at 33 1/3 or 78 r.p.m.; and 96 to 120 lines, either inside or out. Either electromagnetic or crystal playback head available. Turntable is heavy cast-aluminum.

RADIO WITTIQUIZ

(Continued from page 442)

ANSWERS

- | | | |
|-------|-------|-------|
| (39b) | (44b) | (48d) |
| (40b) | (45c) | (49b) |
| (41c) | (46c) | (50c) |
| (42b) | (47c) | (51c) |
| (43d) | | |

CONTEST RULES

- (1) An award of a 1-year subscription to Radio-Craft will be given to each person who submits one or more WITTIQUIZZES that the Editors consider suitable for publication in Radio-Craft.
- (2) WITTIQUIZZES should preferably be typed; use only one side of paper.
- (3) Submit as many WITTIQUIZZES as you care to—the more you submit the more chance you have of winning—but each should be good.
- (4) Each WITTIQUIZ must incorporate humorous elements, and must be based on some term used in radio, public address or electronics.
- (5) All answers must be grouped, by question number and correct-answer letter, on a separate sheet of paper.
- (6) All contributions become the property of Radio-Craft. No contributions can be returned.
- (7) This contest is not open to Radio-Craft employees or their relatives.
- (8) The contest for a given month closes on the 15th of the 3rd month preceding magazine-issue date. (For instance, contributions to March, 1938, Radio-Craft, on the newsstands about Feb. 1, must be received at Radio-Craft editorial offices not later than Dec. 15th, 1938.)

Please Say That You Saw It in RADIO-CRAFT

GET THE REAL Inside FACTS ON TELEVISION

Trained Men Will Be In Demand! CAN YOU QUALIFY?

Television is much closer than you imagine. Already commercial in England . . . Just a few details remain before it will be announced here. When it "breaks" there will be a wild scramble for TRAINED TELEVISION MEN. Like in the early days of radio, the men who get in on the "ground floor" NOW, will get the BIG MONEY JOBS! Do you know Television fundamentals? Cathode-ray tube construction? Television transmission? American Television Institute is one of the best equipped Television Laboratories in the world. Under supervision of Mr. U. A. Sanabria, one of the world's foremost television authorities. Let us train you for Television positions earning \$1500, \$2500 to \$20,000 a year. Tuition on easy time payments . . . Complete full-sized "professional" Television equipment included with each course.

FREE!

We have compiled what we believe is the most interesting and authentic data on Television you've ever read. It's yours FREE for the asking. Gives you real INSIDE FACTS . . . Technical details . . . diagrams . . . illustrations . . . cathode ray tube construction data . . . Television operation and transmission . . . and hundreds of other important, interesting FACTS about Television. We will send this data without cost or obligation so you may determine how to qualify for entrance into American Television Institute and how A.T.I. training will benefit you and equip you for the big pay jobs soon to be offered in Television. Clip coupon below and mail it to us NOW!

AMERICAN TELEVISION INSTITUTE

433 E. Erie St., Chicago, Ill. RC138

Gentlemen: Please send me your free Television book and literature. It is understood that all this is free. No obligation. Nothing to pay.

Name Age

Street

City State

Ask your JOBBER for the NEW

for the NEW

STANCOR

"HAMANUAL"

New Tubes . . . New Circuits

16 NEW TRANSMITTERS
5 WATTS TO 1000 WATTS

STANDARD TRANSFORMER CORPORATION
850 BLACKHAWK STREET, CHICAGO

IDEAL XMAS GIFT!

Radio-Electrical EXPERIMENTS



25-Piece Kit! Genuine Commercial Apparatus—Not Toys!

Wire Up thief-detector, extension phone, electric welder, radio code set, electro-plating, arc-furnace, circuit tester, rectifier, 110-volt motor, arc light, 4,000-ft. range, secret service phone, generate sun-tan health rays, make electric stove, etc.

Contains 110-volt A.C. motor, microphone, transformer, polarized test receiver, arc carbons, electro magnet, test compass, plating chemicals, condenser, 110-volt inductances, magnet, anodes, test socket, 110-volt power reducer, test cords, etc., etc.

Our kits used by leading schools!

6 Books Free with Kit! Instr. Manuals, Theory Electricity, Radio, Plans for Expr. Lab., Bench, etc.

SAVE 60% Send only \$3.99 for complete kit and 6 books (value over \$10). Or, send C.O.D. 3c stamp brings catalog.

ELECTRICAL SALVAGE CO., Box 524-60 Lincoln, Nebr.

3.99
6 Books FREE



BRINGS YOU ANY ONE OF THESE 4 FAMOUS RADIO BOOKS

RADIO FANS! Help yourself to a radio education for the price of 10c per book. These books give you a good foundation towards the study of radio. You'll be amazed at the wealth of information contained in them. They are especially written for beginners but are useful review and reference books for all.

Each book contains 32 pages, profusely illustrated with clear, self-explanatory diagrams. They contain over 15,000 words of clear legible type. They are an education in themselves and lay the groundwork for a complete study of radio and electricity.

HOW TO BUILD FOUR DOERLE SHORT-WAVE SETS

Due to a special arrangement with the publishers of **SHORT WAVE CRAFT**, we present in this book complete details for building the Doerle sets, also an excellent power pack if you plan to electrify any of the sets. Contains **EVERYTHING** that has ever been printed on these famous receivers. These are the famous sets that appeared in **SHORT WAVE CRAFT**: "A 2-Tube Receiver that Reaches the 12,500 Mile Mark," by Walter C. Doerle, "A 3-Tube 'Signal Gripper,'" by Walter C. Doerle, "The Doerle

HOW TO MAKE THE MOST POPULAR ALL-WAVE 1- AND 2-TUBE RECEIVERS

This book contains a number of excellent 1- and 2-tube sets, some of which have appeared in past issues of **RADIO-CRAFT**. These sets are not toys, but have been carefully engineered. They are not experiments. To mention only a few of the sets the following will give you an idea. The Megadyne 1-Tube Pentode Loudspeaker Set, by HUGO Gernsback—Electrifying The Megadyne—How to Make a 1-Tube Loudspeaker set, by W. F. Cheney—How to Make a Simple 1-Tube All-Wave Electric Set, by F. W. Harrison—How to Build a Board-Two All-Wave Electric Set, by J. T. Bernsey, and others.

Each set is fully described in simple language so that anyone can build with limited means and with practically no experience. Worth-while all-wave radio set. Has 30 illustrations.

ALTERNATING CURRENT FOR BEGINNERS

This book gives the beginner a foothold in electricity and radio. Electric circuits are explained... this includes Ohm's Law, alternating current, sine waves, volts, amperes, watts, condensers, transformers, motors and generators, A.C. instruments, house-wiring systems, electrical appliances and electric lamps. Here are some of the practical experiments which you can perform. Simple tests for differentiating between A.C. and D.C.; how to light a lamp by induction; making a simple electric horn; demagnetizing a watch; testing motor armatures; charging storage batteries from A.C.; making A.C. electromagnets; frying eggs on a cake of ice; making A.C. motors and many others. Has 42 illustrations.

ALL ABOUT AERIALS

In simple, understandable language this book explains the theory underlying the various types of aerials: the inverted "L," the Doublet, etc. It explains how noise-free reception can be obtained, how low-impedance transmission lines work; why transposed lead-ins are used. It gives in detail the construction of aerials suitable for long-wave broadcast receivers, for

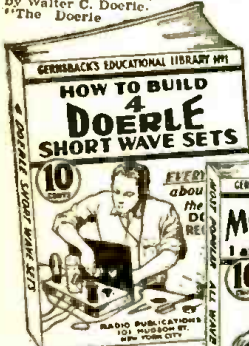

"2-Tube" Adapted to A. C. Operation. "The Doerle 3-Tube 'Signal Gripper' Electrified," and "The Doerle 4-Tube 'Band Spread.'" Has 30 illustrations. **10c postpaid**



Each set is fully described in simple language so that anyone can build with limited means and with practically no experience. Worth-while all-wave radio set. Has 30 illustrations. **10c postpaid**



Remember that each book has 32 pages and contains over 15,000 words. Each book has from 30 to 66 fine illustrations. **POSITIVELY THE GREATEST 10c VALUE IN RADIO BOOKS EVER OFFERED TO THE PUBLIC.**

If you do not think that these books are worth the money asked for them, return them within 24 hours and your money will be instantly refunded.

Send for our **FREE circular listing 48 new 10c Publications**

RADIO PUBLICATIONS
99A Hudson St., New York, N. Y.

RADIO PUBLICATIONS
99A Hudson Street, New York, N. Y. RC-1-38

Please send immediately **POSTPAID** the books checked:

- No. 1—How to Build 4 Doerle Short Wave Sets.....10c
- No. 2—How to Make the Most Popular All-Wave 1- and 2-Tube Receivers.....10c
- No. 3—Alternating Current for Beginners.....10c
- No. 4—All About Aerials.....10c

I am enclosing.....c. the price of each book is 10c

Send me **FREE** circular listing 48 new 10c publications.

Name.....

Address.....

City..... State.....

(U. S. Coin or U. S. Stamps acceptable.) Books are sent postpaid.

Vest Pocket Adding Machine

Sturdy Steel Construction. Lifetime Pocket Companion. Adds, Subtracts, Multiplies, Divides. Capacity, 999-999.99. A real machine—guaranteed 5 years. Send name and address. We ship immediately. On delivery, pay postman \$2.50 (plus few cents postage). (Foreign countries send cash.) Your money back after 10 days trial if not satisfied. Thousands of satisfied users. Send for Special Offer to agents.

Free Trial \$2.50

Send no money. Total Cost.....

TAVELLA SALES CO., 21 West Broadway, New York, N. Y.

PATENTS—TRADE MARKS

All cases submitted given personal attention by members of the firm.

Form "Evidence of Conception" and instructions

"How to Establish Your Rights"—Free

LANCASTER, ALL-WINE & ROMMEL
PATENT LAW OFFICES
486 Bowen Bldg. Washington, D. C.

CLASSIFIED ADVERTISEMENTS

Advertisements in this section are inserted at the cost of twelve cents per word for each insertion—name, initials and address each count as one word. Cash should accompany all classified advertisements unless placed by a recognized advertising agency. Not less than ten words are accepted. Advertising for the Feb., 1938, issue should be received not later than Tuesday, Dec. 7, 1937.

RADIO BOOKS

ARE YOU INTERESTED IN LEARNING ABOUT ONE or more of the important branches of radio? If so, turn to page 440 of this issue, and read the advertisement on the RADIO-CRAFT LIBRARY SERIES.

WIND ELECTRIC PLANTS

BUILD WIND LIGHT PLANT. WE SHOW YOU HOW. Complete plans and valuable catalog 10c. Wind Plant parts, Welders, Electric Fences, LeJay Mfr., 451 Lake, Minneapolis, Minn.

SHORT-WAVE RADIO FOLLOWS THE RACES!

(Continued from page 398)

places; walk along the aisles of busy stores, offices, factories; listen to the personal stories, the pro and con opinions of representative people on Main Street of any city; follow the nip-and-tuck football, baseball and other games and sports; take a trip into the bowels of the earth and learn how men make their living, miles underground, digging—digging—digging so that you and I may have the luxuries that we've come to view more in the light of necessities; go to the top of a plateau, right here in the good old U.S.A., where man never before set foot, and join famous scientist-explorers as they roll back the curtain of centuries—all by means of spot broadcasting.

New technique, new equipment, more expert personnel, more ambitious undertakings than any in the past—spot broadcasts that will make past performances seem like little more than appetizers—are on the bill of fare for 1938. Whether you have an all-wave radio set and can enjoy the thrill of picking up the spot broadcasts direct, before they are re-broadcast on the longer wavelengths, or whether you own a radio receiver that covers *only* the regular broadcast band, get your set tuned up, watch the programs, and resolve now to go places, to "follow the races," via "S-W," and the spot broadcast, in 1938!

REMOTE MIXING ACCOMPLISHED IN LATEST P.A. SYSTEMS

(Continued from page 398)

The 2 potentiometers on the remote-control head are wired into the cathode circuits of the new RCA type 1612 input tubes. (These tubes are described in this issue of *Radio-Craft* on pg. 399.) Thus no losses in signal are introduced by the long, remote-control cables. Since the remote potentiometers are not in the signal circuits, remote volume control and mixing may be accomplished at any distance (up to 2,000 ft.) from the amplifier, and this may be done permanently or temporarily. The changeover to remote mixing is accomplished by simply plugging the remote control unit into an 8-contact socket on the front panel of the amplifier chassis and turning the corresponding potentiometers situated on the main amplifier to positions marked "R" on dials.

It is important to note however that an amplifier using remote mixing must have 2 input circuits each using the new 1612 tube which was designed expressly for this purpose. The schematic circuit of one input channel is shown in section A, Fig. 1. In sections C and D are illustrated both the new and old methods of controlling the input of a public-address system.

The remote control unit is available as a separate unit and is connected to the main amplifier by a cable and plug. This arrangement is shown in section B of Fig. 1.

This article has been prepared from data supplied by courtesy of RCA Mfg. Co., Inc., Commercial Sound Division.

"SNOW STATIC" BEING BEATEN BY "FLYING LABORATORY"

(Continued from page 429)

was unable to receive through the static. In closing this paper, I wish to express our appreciation of the assistance, advice and loan of equipment which made this work possible. A number of men gave of their time without compensation, and the manufacturers their personnel and equipment without hope of remuneration.

The author of this article on the problem of snow static as it affects aircraft-radio reception, and discussion of methods being developed to counteract snow static, is Supt. of Communications Laboratory, United Air Lines. The subject matter of this series of articles was recently presented at Denver, Colo., before the Inst. of Aeronautical Science, and the American Assoc. for the Advancement of Science.

Westinghouse Power Generator

Manufactured for U. S. Signal Corps
200 Watt. 110 V. AC

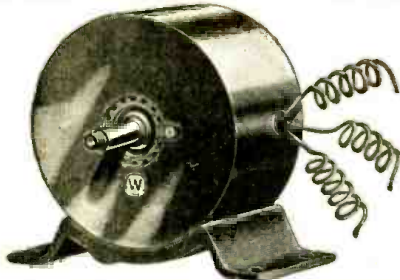

A. C. ELECTRICAL POWER

from a Windmill, from available Waterpower, from your Automobile, from your Motorcycle, from your Bicycle. Foot-pedals or Handcrank (for transportable Radio Transmitters, Strong Floodlights, Advertising Signs); do you want to operate AC Radio sets from 32 V. DC farm light systems; operate two Generators in series to get 200 V. AC; obtain two phase and three phase AC, etc., etc.

There Are Over 25 Applications
Some of which are:

A.C. Dynamo lighting from eight to ten 20 Watt 110 Volt lamps. Short Wave Transmitter supplying 110 Volts AC for operating "Ham" transmitter. Operating 110 V. AC 60 Cycle Radio Receiver in DC districts. Motor Generator. Public Address Systems. Electric Sirens on motor boats, yachts, etc. Camp Lighting. Short Wave artificial "fever" apparatus. Television. Pelton Waterwheel for lighting or other purposes. Airplane: for lighting strong search lights or electric signs. Laboratory work, etc., etc.

1/4 to 1/2 H.P. needed to run Generator.
BLUE-PRINT 22 x 28 in. and Four-Page
8 1/2 x 12 in. INSTRUCTION SHEETS
FREE with Generator.

Generator, as described, including four replacement carbon brushes. Blue-print and instructions **\$7.90**

Send \$2.00 deposit balance C.O.D.
Shipping weight 18 lbs.

(Replacement carbon brushes bought separate \$1.50 per set of four. Set of Instructions bought separate \$1.00.)
MONEY-BACK GUARANTEE

WELLWORTH TRADING COMPANY
560 West Washington Blvd. Dept. RC-138. Chicago, Illinois

DIFFERENT

ENLIGHTENING

One new idea can change your life! Most of us live in a rut—something is needed to shake us out of our lethargy.

NEW IDEAS fills that need. It's the magazine of over 300 new, novel and enlightening ideas—for every member of the family. No idea over 60 days old.

So different is NEW IDEAS that its corners are rounded—its 4 1/2 x 9 inch size will fit a man's inner pocket or a woman's purse. AND, the magazine is pleasantly scented.

ON ALL NEWSSTANDS, or send 25c in coin or stamps to NEW IDEAS, 99-R Hudson Street, New York, N. Y.

ON ALL NEWSSTANDS

THE LATEST RADIO EQUIPMENT

(Continued from page 417)

NEWEST MULTI-METER FEATURES LOW-OHM SCALE (1525)

(The Hickok Electrical Instrument Co.)

THIS instrument, equipped with one of the new (4-in. scale length) Hickok square meters is for general circuit testing on both A.C. and D.C. circuits. A special low-ohms range tests radio loudspeaker coils, R.F. coils and I.F. coils. Instrument has high-sensitivity, 350 micro-ampere movement. New rotary switch eliminates jacks. Contact resistance does not affect readings. Adjustment can be made for changes in rectifier efficiency.

Scale ranges, 2% accurate, are as follows: A.C. volts, 0-10-50-250-500 and 0-1,000; D.C. volts, ditto. Ohms, 0.05-30, 0.5-10,000, 50 ohms to 1 megohm, 500 ohms to 10 megs. D.C. milliamperes, 0-1, 0-5, 0-50, 0-500. Resistor built-in to read 10 megs. with external battery. A.C. voltmeter usable as output meter using same scale as A.C. volts.

Panel is engraved bakelite; steel case measures 7 x 3 1/2 x 4 1/4 ins. high. Unit is complete, self-contained, with rheostat to adjust meter to batteries outside. Four-foot leads fit all tube sockets.

REPLACEMENT MIDGET CONTROLS (1526)

(Centralab)

THE SERVICE trade will welcome this complete line of replacement midget volume controls (and attachable switches). Control is supplied with long shaft milled for push-on knobs; and with insert for push-on knobs requiring set-screw-knob milling. Unit is available in all popular resistance values and tapers from 5,000 ohms to 2 megs. Most of the higher resistance values are available with tone-compensating taps on the resistance strips.

"HAM" DYNAMIC TRANSDUCER (1527)

(Wright-DeCoster, Inc.)

RADIO AMATEURS will be interested in this new, type TBC1.000 dynamic microphone-loudspeaker. Its sensitivity is about -57 db.; little preamplification is required. A D.P.-D.T. switch may be used to change operation from microphone to loudspeaker. Has suede-finish case. Matches into 500 ohms.

(Continued on page 446-48)

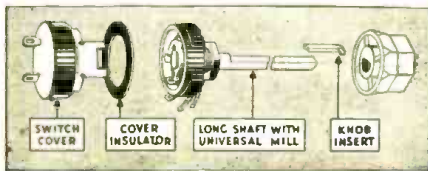

Midget volume control line. (1526)



Ham-radio dynamic transducer. (1527)

WHEN A CONDENSER OUTSELLS ALL OTHERS—

That's New!

CORNELL-DUBILIER TYPE JR-508 IS NOW THE FASTEST SELLING ELECTROLYTIC

HERE ARE THE REASONS WHY:

1. Higher peak voltage breakdown.
2. Extremely low power factor.
3. Negligible leakage characteristics.
4. Accurate, full rated capacity.
5. Small, compact and sturdy.
6. Unconditionally guaranteed against internal corrosion.
7. 27 years' experience behind the product.

MICA PAPER
DYKANOL
WET & DRY ELECTROLYTIC

CORNELL-DUBILIER

ELECTRIC CORPORATION
1014 Hamilton Blvd,
So. Plainfield, New Jersey

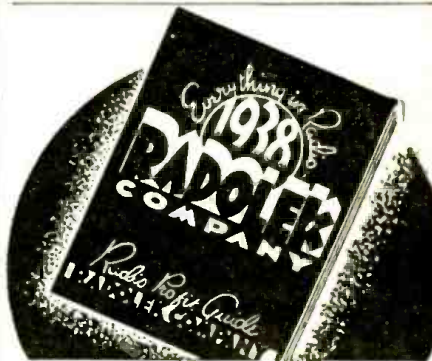

LOWEST PRICES

GUARANTEED QUALITY

FASTEST SERVICE

The New 1938 Radolek Radio Profit Guide contains complete showings of Radio Repair Parts; every repair part for every receiver; Newest Radio Receivers in a complete price range; New 1938 models of Public Address Amplifiers; outputs from 5 to 100 watts—Speakers, Microphones; Test Instruments, Technical Books, Special Tools, Leading Standard Brands! Everything you need in the Radio Business all at Lowest Prices. You save money at Radolek!

Every item you get from Radolek is guaranteed. It must be right or we make it right. Standard merchandise produced by leading manufacturers with Radolek's guarantee added!

Everything in Radio promptly when you want it—and exactly what you want. Radolek's efficient organization insures you the fastest service in the Radio business. 25,000 servicemen customers depend on Radolek service and benefit by Radolek's LOWEST PRICES.

Send now for Radolek Radio Profit Guide. It will help you make money.

RADOLEK

601 W. Randolph, Chicago, Dept. C-13

Send me the 1938 Radolek Radio Profit Guide FREE.

Name

Address

Serviceman? Dealer? Experimenter?

Please Say That You Saw It in RADIO-CRAFT

RADIO

biggest opportunities still ahead

In a decade radio has become a giant industry. The opportunities created are being enjoyed by trained men. The International Correspondence Schools Radio Course, prepared by leading authorities and constantly revised, WILL MAKE YOU A TRAINED MAN! A fascinating book — FREE.

INTERNATIONAL CORRESPONDENCE SCHOOLS

Box 6677-D Scranton, Penna.
Send me—free—information on subject checked:
 Radio Operator Radio Service Man
 Radio Engineer Electrical Engineer

Name.....

Address.....



ALL-WAVE TUNING ASSEMBLY

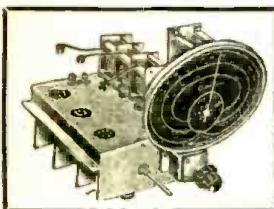

5 Bands
Air Tuned
Band Spread
Calibrated Dial

The MEISSNER ALL-WAVE TUNING ASSEMBLY is the entire "front end" of the radio receiver. Each unit is completely wired and accurately balanced and aligned. **READY FOR USE.** Only six wires to be connected to any 456 kc. I.F. channel. Available either 7.5 to 2140 meters or 5 to 555 meters.
List price **\$38.50**

FREE: Write to department 1-2 for our complete 32 page coil and coil kit catalog.

MEISSNER MFG. CO.
Mt. Carmel Illinois

Now!
BALLAST REPLACEMENT
made **AMAZINGLY SIMPLE!**
Only 4 standard types of Amperite AC-DC Regulators will replace 90% (over 100 types) of AC-DC Ballast Tubes now in use!
WRITE FOR CHART AR.
New Low Price \$1.00 List
AMPERITE AUTOMATIC REGULATORS
561 BROADWAY, N. Y.

FUN WITH SHORT-WAVE RADIO APPARATUS

(Continued from page 401)

that will operate the relay. An example of this is given by the description of a set-up whereby an amateur was able to operate his high-power 160-meter radiophone transmitter, located in his home, entirely from his automobile parked some distance away by means of a 5-meter control link!

The signal from the 5-meter transmitter in the car was picked-up by a 5-meter receiver at the home location. A relay in this receiver's output circuit turned-on the large transmitter; then, the operator's voice, coming from the loudspeaker of the ultra-high-frequency receiver, was re-broadcast through the 160-meter transmitter's microphone.

A 160-meter receiver was used in the car and thus, the amateur was able to work stations on the 160-meter band over the ultra-high-frequency link, the big transmitter always completely under his control!

Now, none of these experiments that have been described have been too complicated for the average amateur to attempt. True, you may not be able to convince an airport manager that he should lend you a plane and pilot, such as the New Jersey group were able to do, but if you've reached that point where the monotony of everyday Ham radio is rapidly making you lose interest in this, greatest of all hobbies, take our suggestion. Think up "some darn foolishness" similar to that we have described and find the fun available from odd and unusual uses of the short-wave and ultra-shortwave bands. Perhaps you'd like to tell us about some of these experiences.

THE LATEST RADIO EQUIPMENT

(Continued from page 445)

WIDE-RANGE I.F. TRANSFORMER (1528)

(Meissner Mfg. Co.)

SERVICE MEN can with only 4 of these standard, double-tuned, wide-range transformers tune to any I.F. required, from 121 to 650 kc., without slip. They are available in either air-core or iron-core type; units for 1,500 kc. and 3,000 kc. operation are available for the radio amateur.

LONG-WAVE CONVERTER FOR CAR-RADIO SETS (1529)

(ABC Radio Laboratories)

THIS 2-TUBE unit when connected ahead of your regular car-radio set gives you the added service of receiving Government weather reports, lake and coastwise ship signals, and beacon and airplane signals! Nothing like this has ever before been commercially available to the car-radio owner.

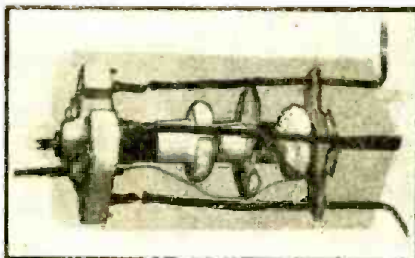

Wide-range I.F. transformers. (1528)



TUNING RANGE 130 TO 430KC (2,307 TO 697 METERS)

An add-on car-radio converter. (1529)

Please Say That You Saw It in RADIO-CRAFT

ADVERTISERS' INDEX

A	
ABC Radio Laboratories.....	436
Akrad Products Company.....	430
Allied Radio Corporation.....	427
American Stationery Company.....	443
American Television Institute.....	443
Amperite Corporation.....	432, 446
Amplifier Co. of America.....	440
Arrow Sales Company.....	436
B	
The Brush Development Co.....	438
Burstein-Applbee Company.....	434
C	
Capitol Radio Engineering Inatt.....	440
Centralab.....	428
Classified Section.....	444
Continental Carbon, Inc.....	436
Cornell-Dubilier Corp.....	434
Coyle Electrical School.....	487
D	
Dodge's Institute.....	438
E	
Electrical Salvage Company.....	443
Electronic Publishing Co.....	427
G	
G&G's Genuine Majestic Herig. & Radio Parts Service.....	434
Goldentone Radio Company.....	434
Greenbank Company.....	441
H	
Hannatund Mfg. Company.....	422
Hydratic Sylvania Corp.....	439
I	
International Correspondence Schools.....	446
International Resistance Company.....	387A
K	
Kenyon Transformer Co., Inc.....	425
L	
Lancaster, Allwine & Rommel.....	444
Lincoln Engineering School.....	441
M	
Meissner Mfg. Company.....	446
Meister Car Products Company.....	434
Millon Radio & Television Labs.....	432
Mohell.....	423
N	
National Rad'o Institute.....	385
National Schools.....	430
National Union Radio Corp.....	425
New Ideas Magazine.....	445
New York YMCA Schools.....	434
P	
Precision Apparatus Corp.....	440
R	
RCA Institutes, Inc.....	432
Radio Circuit Company.....	428
Radio City Products Co.....	438
Radio Constructors Labs.....	424
Radio Publications.....	444
Radio & Technical Publ. Co.....	Back Cover
Radio Training Assoc. of America.....	387B
Radiolex Company.....	443
Raytheon Production Corp.....	426
Readrite Meter Works.....	426
Remington Rand, Inc.....	439
John F. Rider.....	431
The Rostrucian Order.....	430
S	
Solar Mfg. Company.....	438
South Bend Lath Works.....	438
Sprayberry Academy of Radio.....	427
Standard Transformer Corp.....	443
Superior Instrument Company.....	421, 434
Supreme Instruments Corp.....	Inside Front Cover
T	
Tavella Sales Company.....	414
Technifax.....	443
Telex Company.....	411
William A. Thomas Company.....	440
Triplet Elect. Instrument Co.....	429
U	
Universal Microphone Co., Ltd.....	436
Utah Radio Products Company.....	441
W	
Montgomery Ward & Co.....	437
Wellworth Trading Company.....	443, 445
Weston Elect. Instrument Corp.....	Inside Back Cover
Wholesale Radio Service Co.....	433
Wright-Defoster, Inc.....	432
Z	
Zephyr Radio Company.....	440

(While every precaution is taken to insure accuracy, we cannot guarantee against the possibility of an occasional change or omission in the preparation of this index.)

Get the *"Inside Story"*
before you buy any instrument!



WESTON Model 775
Serviset, which consists
of Model 772 (20,000
ohms-per-volt) Analy-
zer—and Model 773
Tube Checker.

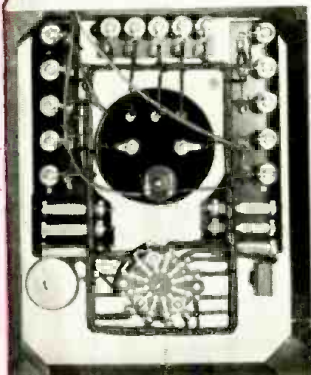

An inside view of the Serviset
...above, Model 772... below,
Model 773.

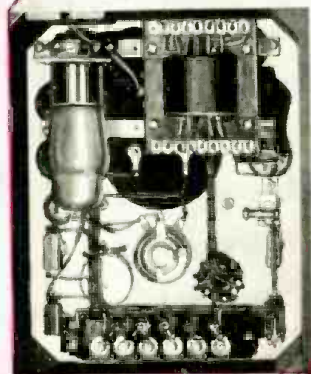

Buy instruments as you would buy a radio set. See what's inside! *Examine the quality of every single part. Carefully inspect the workmanship. Check the fundamental design.* These are the factors which determine the accuracy, dependability and service life of an instrument . . . and should be your guide when buying any test equipment.

After checking the *inside* of the two WESTONS shown above in the combination case . . . instruments also sold singly . . . remember that these instruments give you the following outstanding operating features:

MODEL 772
Analyzer

All AC readings on single AC are
Simplified, easy reading scale .
Decibel readings for sound meas-
urement . Current ranges for auto
testing . New rectifier circuit .
Improved accuracy . Improved
temperature coefficient . Big 50
microampere WESTON meter . . .

MODEL 773
Tube Checker

Individual emission test, each ele-
ment . Individual short test, each
element . Noise test, each element
. Cathode leakage test . Short test
while tubes are hot . Tubes tested
under proper load . Wired for chang-
ing filaments . Flexible switching
arrangement defeats obsolescence.

Send coupon for complete details

WESTON
Radio Instruments

WESTON ELECTRICAL INSTRUMENT CORPORATION

599 Frelinghuysen Avenue, Newark, N. J.

Send full data on all Radio Instruments

Name _____

Address _____

City _____ State _____

STOP GUESSING, Mister!

Use these 2 Ghirardi
SERVICING BOOKS
They'll tell you
WHAT TO DO
and
HOW TO DO IT!



**EVERY MINUTE YOU
DON'T KNOW WHAT TO DO
COSTS YOU HARD CASH!**

Let **GHIRARDI** help you. His
"Modern Radio Servicing" Tells You—

- HOW TO** make the best use of all varieties of servicing instruments—a 420-page section that is a whole book in itself, complete with diagrams and construction data on all types of test equipment needed for modern servicing.
- HOW TO** apply the latest short-cuts in testing receivers in your own shop.
- HOW TO** repair every type of home or auto-radio receiver, old and new, with important new time-saving methods explained.
- HOW TO** understand all the complexities of AVC and QAVC circuits.
- HOW TO** trouble-shoot and quickly get rid of all kinds of difficult troubles such as intermittent reception, hum, distortion, etc., etc.
- HOW TO** align and test receivers with Cathode-Ray Oscilloscopes.
- HOW TO** eliminate noise and interference from all sets.
- HOW TO** service auto-radio, all-wave, high-fidelity, and other special types of receivers.

The Field Data Book Enables You—

- TO** cut down your servicing time by using the "Case Histories" of home and auto-radio sets it contains. This is the greatest collection of Case Histories in the world—over 1,500 of them—and more being added all the time in the Supplements.
- TO** align superhets quickly—with the peak I-F alignment data it provides for over 3,000 receivers.
- TO** save time in Auto-Radio servicing by utilizing the big collection of specialized auto-radio data—car ignition system data and electrical wiring diagrams, etc., which it gives for all American cars.
- TO** "trouble-shoot" for every kind of trouble that crops up—in the least possible time.
- TO** save work, worry and money by using the short-cuts you get in the big collection of 25 additional servicing data charts and tables you'll find in this handy time-saver!

HOW TO GET THESE GREAT BOOKS

Fill out the coupon and mail it right now! You don't risk a single penny—your money back if not thoroughly satisfied. You have to have them!

Sent Postpaid Anywhere!

RADIO & TECHNICAL PUBL. CO.
Dept. RC-18, 45 Astor Place, New York

Here is \$3 for my copies of Ghirardi's
MODERN RADIO SERVICING & **RADIO
FIELD SERVICE DATA** (including
Jan. & June '37 Supplements to Data
Book) postpaid. (Foreign \$4.50)

Please send me Free Circulars describing these books.

NAME

ADDRESS

MONEY-BACK GUARANTEE!

**Radio
FIELD SERVICE
DATA BOOK**
436 PAGES
107 ILLUS.

**BOTH
BOOKS \$6**

**MODERN
RADIO
SERVICING**
1300 PAGES
706 ILLUS.

Get down your Order
on a piece of Paper—

If you don't want to tear out the coupons, just take a piece of paper or your business card—put down the titles of the books and Pocket Trouble Shooters you want, together with your name and address—enclose the amount stated in these ads—and mail to:

RADIO & TECHNICAL PUBLISHING CO.
Dept. RC-18, 45 Astor Place New York, N. Y.

a \$50.00

Radio Course

for only
\$4-

RADIO PHYSICS
COURSE
—
A. GHIRARDI

Ghirardi's Great 972 page

RADIO PHYSICS
COURSE

What a bargain! What a chance for you to really learn radio the easy way. Here's the whole famous Ghirardi RADIO PHYSICS COURSE condensed into one great big 972-page volume—easy to read, easy to understand. This complete instruction course will teach you RADIO, ELECTRICITY, SOUND—and even TELEVISION—while sitting right at home in your own easy chair. Yes, it's all here, all you need to learn is thoroughly explained painstakingly and simply, so you can really understand it at once. Nothing is left out. Ghirardi's marvelous style, freedom from unnecessary mathematics, and more than 500 clear illustrations make everything so clear and simple that you need no previous training to understand it. That's why more radio schools and students use it than any other radio book in the world. All radio instructors recommend it. They say it's the best there is—at any price! You get it at the amazingly low price of only \$4. Where could you do better than this? YOU CAN'T! So order your copy right now—mail the Coupon below—AT ONCE! Remember—every penny of your money back if not fully satisfied!

What You Will Learn From This Book!

- Sound, Speech and Music . . . Electrons . . . Electric Current . . . Electric Units and Circuits . . . Resistance
- Ohm's Law . . . Batteries . . . Magnetism . . . Electromagnetism . . . Transformers . . . Inductance
- Condensers . . . Alternating Current Circuits
- Filters . . . Electrical Measuring Instruments . . . Radio Waves and Radiations . . . Broadcast Stations . . . Receiving Equipment . . . Vacuum Tubes . . . Radio and Audio Frequency Amplification . . . Superheterodynes
- Load Speakers . . . Battery Operated Receivers
- Power Supply Units . . . Electric Receivers . . . Automobile and Aircraft Receivers . . . Phonograph Pickups . . . T. A. Systems . . . Shortwave Receivers
- Photoelectric Cells . . . Television . . . Antennas and Grounds . . . Testing and Servicing Receivers . . . Sound Motion Pictures . . . Appendices . . . Self Review Questions for Self-Study . . . AND LOTS MORE!

FEAR-OFF — FILL OUT — AND MAIL!

RADIO & TECHNICAL PUBLISHING CO.
45 Astor Place, New York, Dept. RC-18

Enclose find \$4. Send my RADIO PHYSICS COURSE at once, postpaid. (Foreign \$4.50)

Send me a free circular describing this book.

Name

Address

MONEY-BACK GUARANTEE

Like Lightning!

Ghirardi's
TWIN GADGETS
Spot Set Troubles

TWIN "TROUBLE SHOOTERS"

Speed Up Your Service Work with the handiest little service aids that ever came to the rescue of hard-working service men! They're great!

Here's how they work: you take up your Gadget; pick out the card marked for the Trouble Symptom you find; flip the card around—and there you are, all the tests to make and all the remedies in a flash. One for HOME radios—one for AUTO radios—each gives Tests and Remedies for over 100 troubles. Save you time and money. Only \$1 a pair (\$1.20 foreign). Clip a dollar to this ad and send for your pair now. Sent postpaid anywhere. Radio & Technical Publ. Co., Dept. RC-18, 45 Astor Pl., N. Y.

MAIL NOW!
\$1 FOR THE PAIR

Money Back Guarantee